



AUSTRALIAN MADE FOR AN AUSTRALIAN LIFESTYLE



Delta Panels Pty Ltd

ABN: 11 147 861 292

Email: info@deltapanel.com

Website: www.deltapanel.com

Head Office:

731 Boundary Road, Richlands, Qld 4077
+61 7 3271 2170

Sydney Depot:

11 The Old Northern Road, Narellan, NSW 2567
+61 2 4611 7712

Version Date: 2024-11-01



SCI QUAL INTERNATIONAL



SCI QUAL INTERNATIONAL



SCI QUAL INTERNATIONAL



THE DELTA PANELS DIFFERENCE

Delta Panels™ is an accredited ISO 9001, ISO 45001 & ISO 14001 manufacturer. Additionally we are a Factory Mutual approved facility and a member of IPCA. Delta Panels™ has received Certificate of Conformity status from CodeMark Australia for a range of roof and wall products.

We have a strong focus on outstanding Customer Service and Quality. This is achieved through state of the art machinery and an exceptional team, dedicated to giving you the best solution for your building project.

We manufacture a wide range of Panel solutions, including Roof, Wall and Patio products, plus a wide range of accessories.

Rely on Delta Panels™ for your next project, and discover the Delta Difference.

THE INSULATED ADVANTAGE

- Large spans, reducing the need for expensive framework
- Up to 50% faster installation time compared to traditional roofing methods
- A complete solution for roofing, including roof, insulation and ceiling
- Continue the smooth ceiling look from inside your house, to your outdoor space
- Reduce heat transfer on hot days to improve your comfort
- Walling made easy with both exterior and interior walls, with insulation
- High R Values for thermal efficiency and compliance with the latest building codes
- Durable, long lasting, and low maintenance

PEACE OF MIND FOR YEARS TO COME

When you purchase a Delta Panels™ Roof, or Patio solution, you are purchasing peace of mind for many years to come. That's why Delta Panels™ backs its Roof products with a **Written 20 Year Warranty***.

Now you can build with confidence, knowing that your project will stand the test of time.

* Conditions Apply.

Refer to the Delta Panels™ website for further information.



CODEMARK - CERTIFICATE OF CONFORMITY

Delta Panels has five (5) separate Certificate of Commodity Certificates covering the following products.

CM 40309

- DeltaTrim-EPS-FR
- DeltaCorroCorro-EPS-FR
- DeltaTrimTrim-EPS-FR
- DeltaTrimCorro-EPS-FR

CM 40330

- DeltaTrim-DualCore
- DeltaOrb-DualCore

CM 40365

- DeltaCool-EPS-FR
- DeltaCool-TPC

CM 40345

- DeltaTrim-MW
- DeltaOrb-MW

CM 40346

- DeltaTrim-MW
- DeltaOrb-MW
- DeltaTrim-EPS-FR
- DeltaCool-EPS-FR

FACTORY MUTUAL ACCREDITATION

Delta Panels is a Factory Mutual certified manufacturing facility. With the following panels verified under the following Class Numbers 4880, 4881, 4882 & 4471

- DeltaCool-TPC - Class 4880, 4881 & 4882
- DeltaOrb-TPC - Class 4880, 4881, 4882 & 4471
- DeltaTrim-TPC - Class 4880, 4881, 4882 & 4471
- DeltaCorroCorro-TPC - Class 4880, 4881, 4882 & 4471



ACCREDITED QUALITY ASSURANCE

All the three (3) Delta Panels manufacturing facilities are accredited with the following:-

- ISO 9001 - Quality Management Systems
- ISO 45001- OH&S
- ISO 14001- Environmental Management Systems

NATA

Delta Panels operates a NATA approved testing laboratory to ensure that quality standards are maintained.

- Accreditation Number 21168



THE DELTA PANELS STORY

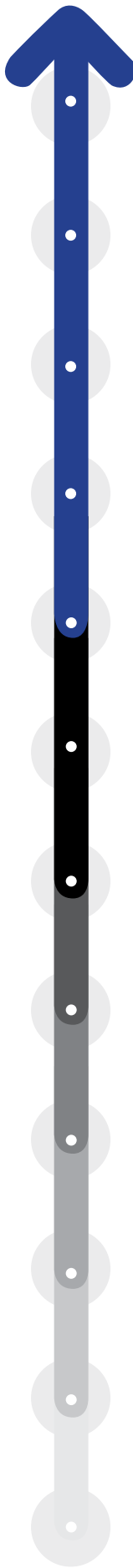

ISO 14001 Certified
NATA Accreditation No. 22168
Site No. 25464

2023



ISO 45001 Certified
Dual Core Patent
Application Number
2021104435

2021



First CodeMark Certificate
of Conformity obtained

2019



ISO 9001 Certified
Delta Insulation Systems Incorporated

2017



Introduced patented LED skylights
Patent Number 2016902870



Delta Panels Incorporated

2010

2024

Factory Mutual Accreditation of
TPC panels, Class 4880, 4881,
4882 & 4471



2022

Thermosetting Phenolic Composite
(TPC) production commenced - Patent
Application 2022903579



2020

Established factory at
731 Boundary Rd



2018

Commenced production of
Mineral Wool panels
Factory Mutual accredited



2015

Dedicated Roof Panel Line installed



2011

Commenced Insulated Roof &
Wall Panel production



THE DELTA RANGE

DELTA PATIO & ROOFING RANGE

DeltaTrim™	6-7
DeltaOrb™	8-9
DeltaCorroCorro™	10-11
DeltaTrimTrim™	12-13
DeltaTrimCorro™	14-15
DeltaSingle™	16-17
DeltaDualCore™ & DeltaFireX™	18-21
BushFire Attack levels	22-23
DeltaMax™	24-25
Roofing Accessories	26-27
Post Kits	28-29
DeltaBeam™	30
DeltaXtremeBeams™	31
DeltaSkylight™	32-35
DeltaLowProfile™ Light	36-37

DELTA COLDROOM RANGE

DeltaCool™ - Coldrooms	38-39
Coldroom Accessories	40-41

DELTA ARCHITECTURAL & HOUSING RANGE

DeltaCool™ - Architectural & Housing	42-45
--------------------------------------	-------

DELTA PANELS - PHYSICAL PROPERTIES

Insulated Core Options	46-47
Joiner & Facer Options	48-49
Testing	50-51
Colour Chart	52-53

Reference Library	54
-------------------	----

DELTA PATIO & ROOFING RANGE



DeltaTrim™

DeltaTrim™ has been designed and engineered in Australia to offer superior performance against other Insulated Panel products.

- Longer panel spans and increased strength due to a higher rib height
- Available in four (4) insulated core options, Expanded Polystyrene Fire Retardant Grade (EPS-FR), Thermosetting Phenolic Composite (TPC), Mineral Wool (MW) & DualCore (DC), to suit the specific requirements of your project.
- DeltaTrim™ with EPS-FR cores have received CodeMark certification, please refer to our web site for full details
- DeltaTrim-TPC is Factory Mutual accredited Class 4880, 4881, 4882 & 4471
- Wide 1000mm panel for faster installation and less visible joins
- Both the use of Smooth and Elegance ceiling finishes extend inside living to the outside world
- Foam filled roof peaks reduce condensation and corrosion
- Angled cable duct holds electrical cables in place during installation
- Please refer to the Delta Panels™ website for full certification details.
- Larger radius corners on ribs improve durability and reduce paint cracking
- Wide range of classic and contemporary colours to match any existing structure
- Written 20 Year Warranty for true peace of mind

* Download technical data information from the Delta Panels™ website

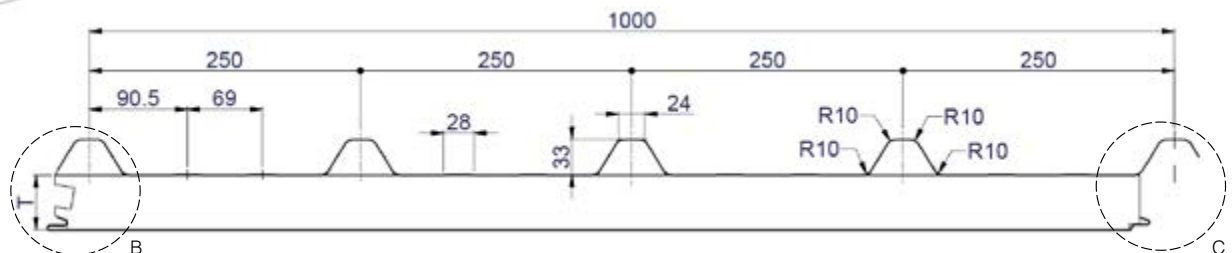
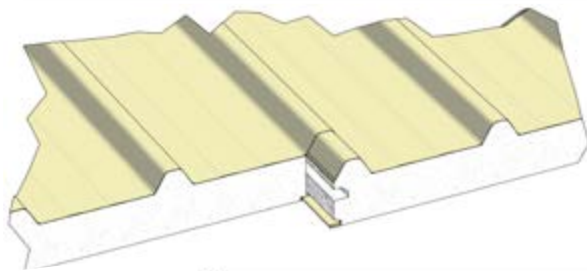

Steel Skin Details	Top Skin	0.42mm / G550 AZ150					
	Bottom Skin	0.60mm / G300 Z275					
Core Material Options	- SL Grade Polystyrene - Fire Retardant Grade - Thermosetting Phenolic Composite - TPC - Mineral Wool - MW						
Thermal Conductivity	- EPS-FR @ 22.5c - 0.042 W/mK - TPC @ 22.5c - 0.0396 W/mK - MW @ 23c - 0.0365 W/mK						
Adhesive	Thermosetting two-part adhesive						
Panel Weight (kgs/m²) based on 0.6mm steel skins	Panel	EPS-FR	TPC	MW			
	50mm	10.58	11.70	-			
	75mm	10.94	12.06	18.5			
	100mm	11.30	12.43	21.0			
	125mm	11.66	12.79	23.5			
	150mm	12.02	13.15	26.0			
	175mm	12.38	13.51	-			
External Roof R Value (m².K/W) AS/NZS 4859 Parts 1 & 2:2018	Panel	EPS-FR		TPC		MW	
		Winter (15°C)	Summer (23°C)	Winter (15°C)	Summer (23°C)	Winter (15°C)	Summer (30°C)
	50mm	1.38	1.36	1.45	1.45	-	-
	75mm	1.90	1.85	2.10	2.05	2.40	2.25
	100mm	2.52	2.43	2.75	2.65	3.10	2.95
	125mm	3.13	3.02	3.40	3.30	3.80	3.60
	150mm	3.69	3.56	4.05	3.90	4.55	4.25
	175mm	4.31	4.15	4.75	4.60	-	-
200mm	4.88	4.68	5.40	5.20	-	-	
Factory Mutual	DeltaTrim-TPC is Accredited Class 4880, 4881, 4882 & 4471						
Sheet Coverage	1000mm						
Length (mm)	Cut to length. Min. of 1800mm						
Thickness (mm)	50, 75, 100, 125, 150, 175, 200						
Minimum Roof Pitch	2°						

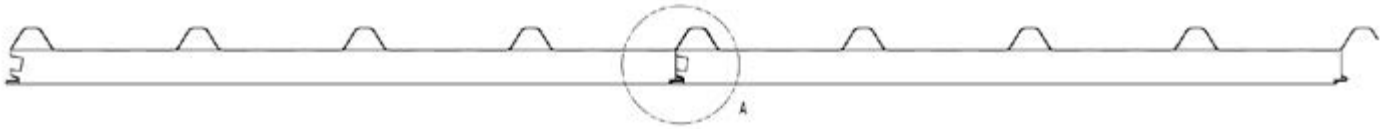

DeltaTrim™ Acoustic Values

Acoustic Testing has been performed in compliance with the requirements of AS 1191-2002 "Acoustics - Method for Laboratory Measurement of Airborne Sound Insulation of Building Elements".

The procedures specified by AS 1276-1979 and AS/NZS ISO 717.1:2004 were used to calculate the Sound Transmission Class (STC) and the Weighted Sound Reduction Index $R_w = 25$ dB.

Handling & Installation

DeltaTrim-EPS-FR & DeltaTrim-TPC are classified as trafficable when used for maintenance purposes. The following recommendations should be observed at all times.

Recommendations

- Wear flat, rubber soled shoes
- Walk over the roof supporting beams
- Spread your weight over as many roof crests as possible
- Crawl boards should be used when accessing areas not supported by a structure

DeltaTrim-MW core material is fibrous as such it is easy to fracture the mineral wool fibres if handled and installed incorrectly. Please ensure that correct lifting equipment is used when the panels are transported and lifted into position. Refer to the Handling & Installation Manual - Roof Systems for the correct Crane & Sling Procedures.

Bushfire Attack Levels (BAL)

DeltaTrim-TPC achieved a Bushfire Attack Level (BAL) of AA29, as per CSIRO report Number FSZ 2411 issued 21-12-2023, when tested in accordance with the test method As 1530.8.1

Colour Chart - Warranty

Expanded Polystyrene Fire-Retardant Grade (EPS-FR) is a thermoplastic that when exposed to high levels of sustained heat is subject to changes in its structural properties. On extremely hot days with no cooling wind, dark colours have been recorded as reaching extreme temperatures. The manufacturer of the steel recommends the following colours, subject to conditions of use, will maintain a temperature under 78.0oC dry heat (see clause 9, sub-clause j of our product Warranty). Please refer to Clause 12 of the Warranty – Roof Products for full details.

- Off White / Surfmist®
- Gull Grey / Shale Grey™
- Merino / Paperbark®
- Mist Green / Paperbark®
- Smooth Cream / Classic Cream™
- Hamptons White
- Zinc
- Birch / Dune®
- Armour Grey / Windspray



To maintain Warranty cover with dark colours it is therefore recommended that a Thermosetting Phenolic Composite (TPC) or Mineral Wool (MW) core be used for all colours not listed above.

© Colour names are registered trademarks of Bluescope Steel Limited
™ Colour names are trademarks of Bluescope Steel Limited

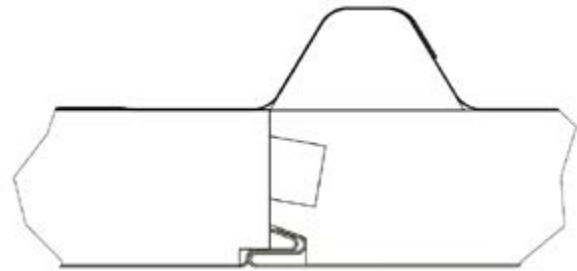

Detail A

Exposure to the External Surface - AS 3959-2009

Brnz Fire Test Certificate FC10893-01-02-C1

Early Fire Hazard Properties AS 1530-1999

DeltaTrim™-EPS-FR Panel

AWTA Test Report 18-006076 14-11-2018

Index	Test Range	External Top Skin
Ignitability	0-20	0
Spread of Flame	0-10	0
Heat Evolved	0-10	0
Smoke Developed	0-10	2

DeltaTrim™ Fixing Details

Crest fixing only. One fixing every second crest

Panel Thickness (mm)	Fixing into Steel	Fixing into Timber
50	Tek 14 x 135 Hex Head Screw	T17 14 x 125 Hex Head Screw
75	Tek 14 x 150 Hex Head Screw	T17 14 x 150 Hex Head Screw
100	Tek 14 x 175 Hex Head Screw	T17 14 x 175 Hex Head Screw
125	Tek 14 x 200 Hex Head Screw	T17 14 x 200 Hex Head Screw
150	Tek 14 x 230 Hex Head Screw	T17 14 x 230 Hex Head Screw
175	Tek 14 x 260 Hex Head Screw	T17 14 x 265 Hex Head Screw
200	Tek 14 x 260 Hex Head Screw	T17 14 x 300 Hex Head Screw

Use Cyclone Plate and Neo Washer on each fixing

Upon Installation the overlap needs to be stitch screwed or riveted every 300mm.

* Please refer to the web page for the available colour range, paint finishes and relevant warranty conditions.

DELTA PATIO & ROOFING RANGE



DeltaOrb™

DeltaOrb™ offers classical corrugated lines, with all of the benefits of modern Insulated Panel technologies.

- Longer panel spans and increased strength due to a deeper profile
- Available in three (3) insulated core options, Expanded Polystyrene Fire Retardant Grade (EPS-FR), Thermosetting Phenolic Composite (TPC) & DualCore (DC), to suit the specific requirements of your project.
- DeltaOrb™ with EPS-FR cores have received CodeMark certification, please refer to our web site for full details
- DeltaOrb-TPC is Factory Mutual accredited Class 4880, 4881, 4882 & 4471
- Wide 1000mm panel for faster installation and less visible joints
- Both the use of Smooth and Elegance ceiling finishes extend inside living to the outside world
- Foam filled roof corrugations reduce condensation and corrosion
- Angled cable duct holds electrical cables in place during installation
- Please refer to the Delta Panels™ website for full certification details.
- Maintain the traditional character of Australian roofing
- Wide range of classic and contemporary colours to match any existing structure
- Written 20 Year Warranty for true peace of mind

* Download technical data information from the Delta Panels™ website

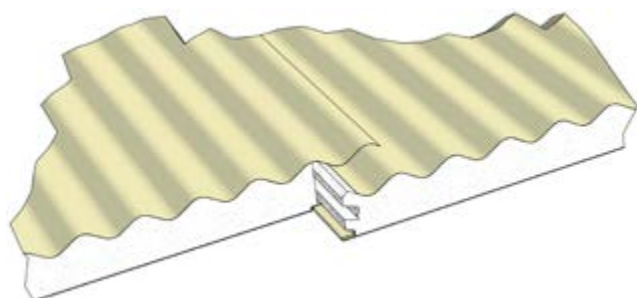

Steel Skin Details	Top Skin	0.42mm / G550 AZ150				
	Bottom Skin	0.60mm / G300 Z275				
Core Material Options	- SL Grade Polystyrene - Fire Retardant Grade - Thermosetting Phenolic Composite - TPC					
Thermal Conductivity	- EPS-FR @ 22.5c - 0.042 W/mK - TPC @ 22.5c - 0.0396 W/mK					
Adhesive	Thermosetting two-part adhesive					
Panel Weight (kgs/m²) based on 0.6mm steel skins	Panel	EPS-FR	TPC			
	50mm	10.58	11.70			
	75mm	10.94	12.06			
	100mm	11.30	12.43			
	125mm	11.66	12.79			
	150mm	12.02	13.15			
	175mm	12.38	13.51			
	200mm	12.72	13.86			
External Roof R Value (m².K/W) AS/NZS 4859 Parts 1 & 2:2018	Panel	EPS-FR		TPC		
		Winter (15°C)	Summer (23°C)	Winter (15°C)	Summer (23°C)	
	50mm	1.38	1.36	1.45	1.45	
	75mm	1.90	1.85	2.10	2.05	
	100mm	2.52	2.43	2.75	2.65	
	125mm	3.13	3.02	3.40	3.30	
	150mm	3.69	3.56	4.05	3.90	
	175mm	4.31	4.15	4.75	4.60	
200mm	4.88	4.68	5.40	5.20		
Factory Mutual	DeltaOrb-TPC is Accredited Class 4880, 4881, 4882 & 4472					
Sheet Coverage	1000mm					
Length (mm)	Cut to length. Min. of 1800mm					
Thickness (mm)	50, 75, 100, 125, 150, 175, 200					
Minimum Roof Pitch	Building Classes 1-9	-5°				
	Building Class 10	-3°				

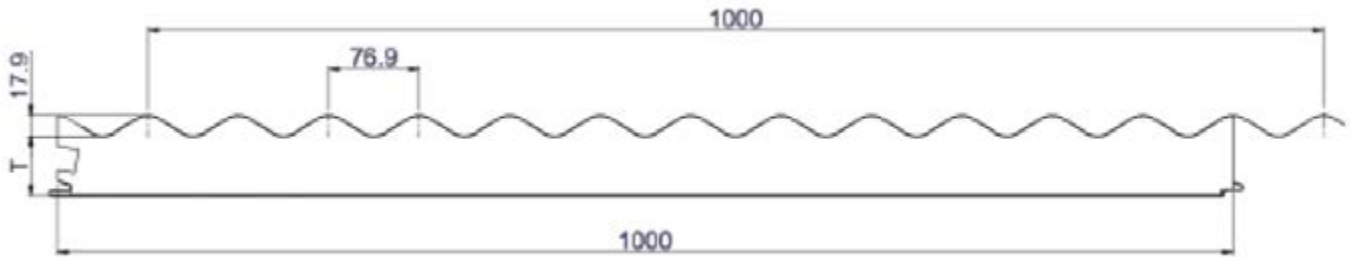

DeltaOrb™ Acoustic Values

Acoustic Testing has been performed in compliance with the requirements of AS 1191-2002 "Acoustics - Method for Laboratory Measurement of Airborne Sound Insulation of Building Elements".

The procedures specified by AS 1276-1979 and AS/NZS ISO 717.1:2004 were used to calculate the Sound Transmission Class (STC) and the Weighted Sound Reduction Index $R_w = 25$ dB.

Handling & Installation

DeltaOrb-EPS-FR & DeltaOrb-TPC are classified as trafficable when used for maintenance purposes. The following recommendations should be observed at all times.

Recommendations

- Wear flat, rubber soled shoes
- Walk over the roof supporting beams
- Spread your weight over as many roof crests as possible
- Crawl boards should be used when accessing areas not supported by a structure

Bushfire Attack Levels (BAL)

DeltaOrb-TPC achieved a Bushfire Attack Level (BAL) of AA29, as per CSIRO report Number FSZ 2411 issued 21-12-2023, when tested in accordance with the test method As 1530.8.1

Colour Chart - Warranty

Expanded Polystyrene Fire-Retardant Grade (EPS-FR) is a thermoplastic that when exposed to high levels of sustained heat is subject to changes in its structural properties. On extremely hot days with no cooling wind, dark colours have been recorded as reaching extreme temperatures. The manufacturer of the steel recommends the following colours, subject to conditions of use, will maintain a temperature under 78.0oC dry heat (see clause 9, sub-clause j of our product Warranty). Please refer to Clause 12 of the Warranty – Roof Products for full details.

- Off White / Surfmist®
- Gull Grey / Shale Grey™
- Merino / Paperbark®
- Mist Green / Paperbark®
- Smooth Cream / Classic Cream™
- Hamptons White
- Zinc
- Birch / Dune®
- Armour Grey / Windspray



To maintain Warranty cover with dark colours it is therefore recommended that a Thermosetting Phenolic Composite (TPC) core be used for all colours not listed above.

© Colour names are registered trademarks of Bluescope Steel Limited
™ Colour names are trademarks of Bluescope Steel Limited

Early Fire Hazard Properties AS 1530-1999 DeltaOrb™-EPS-FR Panel

AWTA Test Report 18-006076 14-11-2018

Ignitability	0-20	0
Spread of Flame	0-10	0
Heat Evolved	0-10	0
Smoke Developed	0-10	2

DeltaOrb™ Fixing Details

Crest fixing only. One fixing every second crest

Panel Thickness (mm)	Fixing into Steel	Fixing into Timber
50	Tek 14 x 115 Hex Head Screw	T17 14 x 125 Hex Head Screw
75	Tek 14 x 135 Hex Head Screw	T17 14 x 150 Hex Head Screw
100	Tek 14 x 150 Hex Head Screw	T17 14 x 175 Hex Head Screw
125	Tek 14 x 175 Hex Head Screw	T17 14 x 200 Hex Head Screw
150	Tek 14 x 200 Hex Head Screw	T17 14 x 230 Hex Head Screw
175	Tek 14 x 230 Hex Head Screw	T17 14 x 265 Hex Head Screw
200	Tek 14 x 260 Hex Head Screw	T17 14 x 300 Hex Head Screw

Use Cyclone Plate and Neo Washer on each fixing

Upon Installation the overlap needs to be stitch screwed or riveted every 300mm.

* Please refer to the web page for the available colour range, paint finishes and relevant warranty conditions.

DeltaCorroCorro™

DeltaCorroCorro™ offers double-sided classical corrugated lines, with all of the benefits of modern Insulated Panel technologies.

- Incredible spans and increased strength due to a deeper profile
- Available in two (2) insulated core options, Expanded Polystyrene Fire Retardant Grade (EPS-FR) & Thermosetting Phenolic Composite (TPC), to suit the specific requirements of your project.
- DeltaCorroCorro™ with EPS-FR cores have received Code Mark certification, please refer to our web site for full details
- DeltaCorroCorro-TPC is Factory Mutual accredited Class 4880, 4881, 4882 & 4471
- Wide 1000mm panel for faster installation and less visible joints
- Classical corrugated appearance on both sides for a striking aesthetic
- Foam filled roof corrugations reduce condensation and corrosion
- Angled cable duct holds electrical cables in place during installation
- Impressive insulating and sound dampening properties
- Perfect for large multi-residential or commercial applications
- Wide range of classic and contemporary colours to match any existing structure
- Written 20 Year Warranty for true peace of mind

* Download technical data information from the Delta Panels™ website

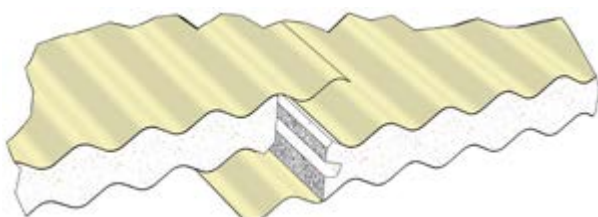

Steel Skin Details	Top Skin	0.42mm / G550				
	Bottom Skin	0.42mm / G550				
Core Material Options	- SL Grade Polystyrene - Fire Retardant Grade - Thermosetting Phenolic Composite - TPC					
Thermal Conductivity	- EPS-FR @ 22.5c - 0.042 W/mK - TPC @ 22.5c - 0.0396 W/mK					
Adhesive	Thermosetting two-part adhesive					
Panel Weight (kgs/m²) based on 0.6mm steel skins	Panel	EPS-FR	TPC			
	75mm	10.94	12.06			
	100mm	11.30	12.43			
	125mm	11.66	12.79			
	150mm	12.02	13.15			
	175mm	12.38	13.51			
	200mm	12.72	13.86			
External Roof R Value (m².K/W) AS/NZS 4859 Parts 1 & 2:2018	Panel	EPS-FR		TPC		
		Winter (15°C)	Summer (23°C)	Winter (15°C)	Summer (23°C)	
	75mm	1.90	1.85	2.10	2.05	
	100mm	2.52	2.43	2.75	2.65	
	125mm	3.13	3.02	3.40	3.30	
	150mm	3.69	3.56	4.05	3.90	
	175mm	4.31	4.15	4.75	4.60	
200mm	4.88	4.68	5.40	5.20		
Factory Mutual	DeltaCorroCorro-TPC is Accredited Class 4880, 4881, 4882 & 4472					
Sheet Coverage	1000mm					
Length (mm)	Cut to length. Min. of 1800mm					
Thickness (mm)	75, 100, 125, 150, 175, 200, 225, 250					
Minimum Roof Pitch	Building Classes 1-9	-5°				
	Building Class 10	-3°				

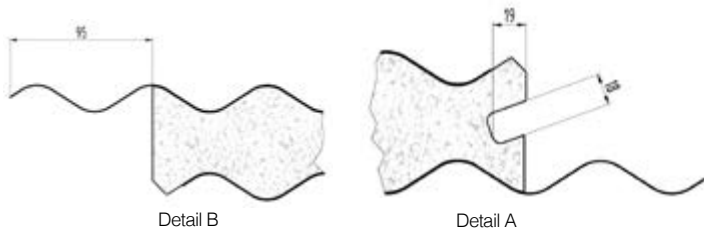
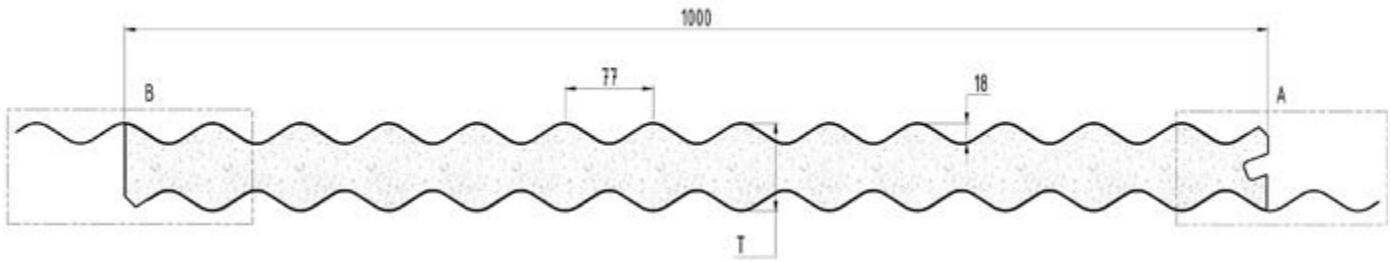

DeltaCorroCorro™ Acoustic Values

Acoustic Testing has been performed in compliance with the requirements of AS 1191-2002 "Acoustics - Method for Laboratory Measurement of Airborne Sound Insulation of Building Elements".

The procedures specified by AS 1276-1979 and AS/NZS ISO 717.1:2004 were used to calculate the Sound Transmission Class (STC) and the Weighted Sound Reduction Index (Rw) of =25dB

Handling & Installation

DeltaCorroCorro-EPS-FR & DeltaCorroCorro-TPC are classified as trafficable when used for maintenance purposes. The following recommendations should be observed at all times.

Recommendations

- Wear flat, rubber soled shoes
- Walk over the roof supporting beams
- Spread your weight over as many roof crests as possible
- Crawl boards should be used when accessing areas not supported by a structure

Colour Chart - Warranty

Expanded Polystyrene Fire-Retardant Grade (EPS-FR) is a thermoplastic that when exposed to high levels of sustained heat is subject to changes in its structural properties. On extremely hot days with no cooling wind, dark colours have been recorded as reaching extreme temperatures. The manufacturer of the steel recommends the following colours, subject to conditions of use, will maintain a temperature under 78.0oC dry heat (see clause 9, sub-clause j of our product Warranty). Please refer to Clause 12 of the Warranty – Roof Products for full details.

- Off White / Surfmist®
- Gull Grey / Shale Grey™
- Merino / Paperbark®
- Mist Green / Paperbark®
- Smooth Cream / Classic Cream™
- Hamptons White
- Zinc
- Birch / Dune®
- Armour Grey / Windspray

To maintain Warranty cover with dark colours it is therefore recommended that a Thermosetting Phenolic Composite (TPC) core be used for all colours not listed above.

© Colour names are registered trademarks of Bluescope Steel Limited
™ Colour names are trademarks of Bluescope Steel Limited



**Early Fire Hazard Properties AS 1530-1999
DeltaCorroCorro™ - EPS-FR Panel**

Index	Test Range	External Top Skin
Ignitability	0-20	0
Spread of Flame	0-10	0
Heat Evolved	0-10	0
Smoke Developed	0-10	2

DeltaCorroCorro™ Fixing Details
Crest fixing only. One fixing every second crest

Panel Thickness (mm)	Fixing into Steel	Fixing into Timber
75	Tek 14 x 115 Hex Head Screw	T17 14 x 125 Hex Head Screw
100	Tek 14 x 135 Hex Head Screw	T17 14 x 150 Hex Head Screw
125	Tek 14 x 150 Hex Head Screw	T17 14 x 175 Hex Head Screw
150	Tek 14 x 175 Hex Head Screw	T17 14 x 200 Hex Head Screw
175	Tek 14 x 200 Hex Head Screw	T17 14 x 230 Hex Head Screw
200	Tek 14 x 230 Hex Head Screw	T17 14 x 265 Hex Head Screw
225	Tek 14 x 260 Hex Head Screw	T17 14 x 265 Hex Head Screw
250	Tek 14 x 300 Hex Head Screw	T17 14 x 300 Hex Head Screw

Use Cyclone Plate and Neo Washer on each fixing
Upon Installation the overlap needs to be stitch screwed or riveted every 300mm.

* Please refer to the web page for the available colour range, paint finishes and relevant warranty conditions.

DeltaTrimTrim™

DeltaTrimTrim™ offers double-sided classical roll-formed profile, with all of the benefits of modern Insulated Panel technologies.

- Longer spans and increased strength due to a deeper profile
- Available in two (2) insulated core options, Expanded Polystyrene Fire Retardant Grade (EPS-FR) & Thermosetting Phenolic Composite (TPC), to suit the specific requirements of your project.
- DeltaTrimTrim™ with EPS-FR cores have received Code Mark certification, please refer to our web site for full details
- Wide 1000mm panel for faster installation and less visible joints
- Classical profiled appearance on both sides for a striking aesthetic
- Foam filled profiled peaks reduce condensation and corrosion
- Angled cable duct holds electrical cables in place during installation
- Impressive insulating and sound dampening properties
- Perfect for large multi-residential or commercial applications
- Wide range of classic and contemporary colours to match any existing structure
- Written 20 Year Warranty for true peace of mind

* Download technical data information from the Delta Panels™ website

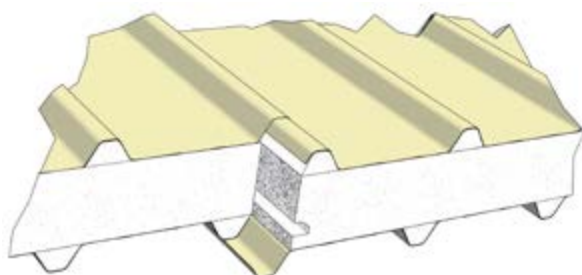

Steel Skin Details	Top Skin	0.42mm / G550 AZ150				
	Bottom Skin	0.42mm / G550 AZ150				
Core Material Options	- SL Grade Polystyrene - Fire Retardant Grade - Thermosetting Phenolic Composite - TPC					
Thermal Conductivity	- EPS-FR @ 22.5c - 0.042 W/mK - TPC @ 22.5c - 0.0396 W/mK					
Adhesive	Thermosetting two-part adhesive					
Panel Weight (kgs/m²) based on 0.6mm steel skins	Panel	EPS-FR	TPC			
	75mm	10.94	12.06			
	100mm	11.30	12.43			
	125mm	11.66	12.79			
	150mm	12.02	13.15			
	175mm	12.38	13.51			
	200mm	12.72	13.86			
External Roof R Value (m².K/W) AS/NZS 4859 Parts 1 & 2:2018	Panel	EPS-FR		TPC		
		Winter (15°C)	Summer (23°C)	Winter (15°C)	Summer (23°C)	
	75mm	1.90	1.85	2.10	2.05	
	100mm	2.52	2.43	2.75	2.65	
	125mm	3.13	3.02	3.40	3.30	
	150mm	3.69	3.56	4.05	3.90	
	175mm	4.31	4.15	4.75	4.60	
200mm	4.88	4.68	5.40	5.20		
Sheet Coverage	1000mm					
Length (mm)	Cut to length. Min. of 1800mm					
Thickness (mm)	75, 100, 125, 150, 175, 200					
Minimum Roof Pitch	2°					

DELTA PATIO & ROOFING RANGE

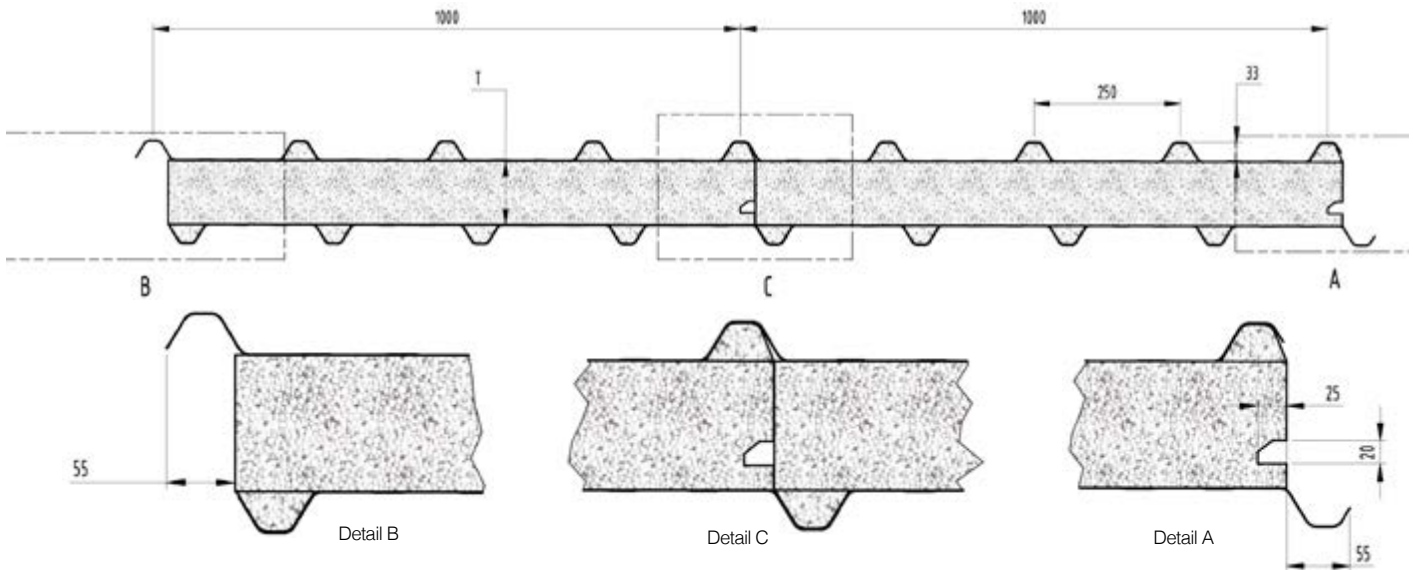

DeltaTrimTrim™ Acoustic Values

Acoustic Testing has been performed in compliance with the requirements of AS 1191-2002 "Acoustics - Method for Laboratory Measurement of Airborne Sound Insulation of Building Elements".

The procedures specified by AS 1276-1979 and AS/NZS ISO 717.1:2004 were used to calculate the Sound Transmission Class (STC) and the Weighted Sound Reduction Index (Rw) of =25dB

Handling & Installation

DeltaTrimTrim-EPS-FR & DeltaTrimTrim-TPC are classified as trafficable when used for maintenance purposes. The following recommendations should be observed at all times.

Recommendations

- Wear flat, rubber soled shoes
- Walk over the roof supporting beams
- Spread your weight over as many roof crests as possible
- Crawl boards should be used when accessing areas not supported by a structure

Colour Chart - Warranty

Expanded Polystyrene Fire-Retardant Grade (EPS-FR) is a thermoplastic that when exposed to high levels of sustained heat is subject to changes in its structural properties. On extremely hot days with no cooling wind, dark colours have been recorded as reaching extreme temperatures. The manufacturer of the steel recommends the following colours, subject to conditions of use, will maintain a temperature under 78.0°C dry heat (see clause 9, sub-clause j of our product Warranty). Please refer to Clause 12 of the Warranty – Roof Products for full details.

- Off White / Surfmist®
- Gull Grey / Shale Grey™
- Merino / Paperbark®
- Mist Green / Paperbark®
- Smooth Cream / Classic Cream™
- Hamptons White
- Zinc
- Birch / Dune®
- Armour Grey / Windspray



To maintain Warranty cover with dark colours it is therefore recommended that a Thermosetting Phenolic Composite (TPC) core be used for all colours not listed above.

© Colour names are registered trademarks of Bluescope Steel Limited
 ™ Colour names are trademarks of Bluescope Steel Limited

Early Fire Hazard Properties AS 1530-1999 DeltaTrimTrim™ - EPS-FR Panel

Index	Test Range	External Top Skin
Ignitability	0-20	0
Spread of Flame	0-10	0
Heat Evolved	0-10	0
Smoke Developed	0-10	2

DeltaTrimTrim™ Fixing Details

Crest fixing only. One fixing every second crest

Panel Thickness (mm)	Fixing into Steel	Fixing into Timber
75	Tek 14 x 200 Hex Head Screw	T17 14 x 200 Hex Head Screw
100	Tek 14 x 230 Hex Head Screw	T17 14 x 230 Hex Head Screw
125	Tek 14 x 230 Hex Head Screw	T17 14 x 230 Hex Head Screw
150	Tek 14 x 260 Hex Head Screw	T17 14 x 265 Hex Head Screw
175	Tek 14 x 300 Hex Head Screw	T17 14 x 300 Hex Head Screw
200	Tek 14 x 300 Hex Head Screw	T17 14 x 300 Hex Head Screw

Use Cyclone Plate and Neo Washer on each fixing
 Upon Installation the overlap needs to be stitch screwed or riveted every 300mm.

* Please refer to the web page for the available colour range, paint finishes and relevant warranty conditions.

DELTA PATIO & ROOFING RANGE



DeltaTrimCorro™

DeltaTrimCorro™ combines the classic roll-formed profiles of DeltaTrim™ and DeltaOrb™ into one panel, with all of the benefits of modern Insulated Panel technologies.

- Increased spans and strength due to a combination of the different profiles
- Available in two (2) insulated core options, Expanded Polystyrene Fire Retardant Grade (EPS-FR) & Thermosetting Phenolic Composite (TPC), to suit the specific requirements of your project.
- DeltaTrimCorro™ with EPS-FR cores have received Code Mark certification, please refer to our web site for full details
- Wide 1000mm panel for faster installation and less visible joints
- Classical appearance on both sides for a striking aesthetic
- Foam filled roof peaks reduce condensation and corrosion
- Angled cable duct holds electrical cables in place during installation
- Impressive insulating and sound dampening properties
- Perfect for large multi-residential or commercial applications
- Wide range of classic and contemporary colours to match any existing structure
- Written 20 Year Warranty for true peace of mind

* Download technical data information from the Delta Panels™ website

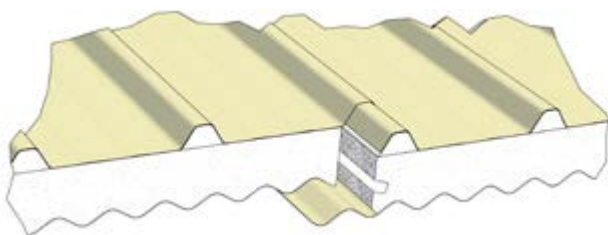

Steel Skin Details	Top Skin	0.42mm / G550 AZ150
	Bottom Skin	0.42mm / G550 AZ150

Core Material Options	- SL Grade Polystyrene - Fire Retardant Grade - Thermosetting Phenolic Composite - TPC
------------------------------	---

Thermal Conductivity	- EPS-FR @ 22.5c - 0.042 W/mK - TPC @ 22.5c - 0.0396 W/mK
-----------------------------	--

Adhesive	Thermosetting two-part adhesive
-----------------	---------------------------------

	Panel	EPS-FR	TPC
Panel Weight (kgs/m²) based on 0.6mm steel skins	75mm	10.94	12.06
	100mm	11.30	12.43
	125mm	11.66	12.79
	150mm	12.02	13.15
	175mm	12.38	13.51
	200mm	12.72	13.86

	Panel	EPS-FR		TPC	
		Winter (15°C)	Summer (23°C)	Winter (15°C)	Summer (23°C)
External Roof R Value (m².K/W) AS/NZS 4859 Parts 1 & 2:2018	75mm	1.90	1.85	2.10	2.05
	100mm	2.52	2.43	2.75	2.65
	125mm	3.13	3.02	3.40	3.30
	150mm	3.69	3.56	4.05	3.90
	175mm	4.31	4.15	4.75	4.60
	200mm	4.88	4.68	5.40	5.20

Sheet Coverage	1000mm
-----------------------	--------

Length (mm)	Cut to length. Min. of 1800mm
--------------------	-------------------------------

Thickness (mm)	75, 100, 125, 150, 175, 200
-----------------------	-----------------------------

Minimum Roof Pitch	2° - Trim/Corro 3° - Corro/Trim for Class 10 Buildings
---------------------------	---

DELTA PATIO & ROOFING RANGE

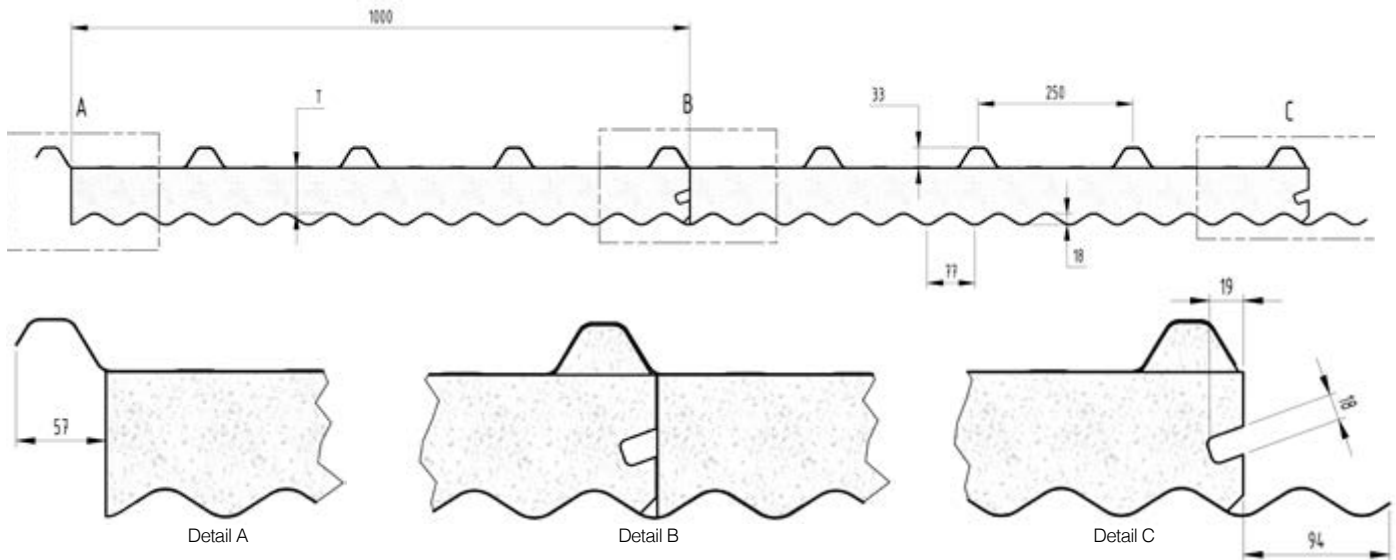

DeltaTrimCorro™ Acoustic Values

Acoustic Testing has been performed in compliance with the requirements of AS 1191-2002 "Acoustics - Method for Laboratory Measurement of Airborne Sound Insulation of Building Elements".

The procedures specified by AS 1276-1979 and AS/NZS ISO 717.1:2004 were used to calculate the Sound Transmission Class (STC) and the Weighted Sound Reduction Index (Rw) of =25dB

Handling & Installation

DeltaTrimCorro-EPS-FR & DeltaTrimCorro-TPC are classified as trafficable when used for maintenance purposes. The following recommendations should be observed at all times.

Recommendations

- Wear flat, rubber soled shoes
- Walk over the roof supporting beams
- Spread your weight over as many roof crests as possible
- Crawl boards should be used when accessing areas not supported by a structure

Colour Chart - Warranty

Expanded Polystyrene Fire-Retardant Grade (EPS-FR) is a thermoplastic that when exposed to high levels of sustained heat is subject to changes in its structural properties. On extremely hot days with no cooling wind, dark colours have been recorded as reaching extreme temperatures. The manufacturer of the steel recommends the following colours, subject to conditions of use, will maintain a temperature under 78.0oC dry heat (see clause 9, sub-clause j of our product Warranty). Please refer to Clause 12 of the Warranty – Roof Products for full details.

- Off White / Surfemist®
- Gull Grey / Shale Grey™
- Merino / Paperbark®
- Mist Green / Paperbark®
- Smooth Cream / Classic Cream™
- Hamptons White
- Zinc
- Birch / Dune®
- Armour Grey / Windspray



To maintain Warranty cover with dark colours it is therefore recommended that a Thermosetting Phenolic Composite (TPC) core be used for all colours not listed above.

® Colour names are registered trademarks of Bluescope Steel Limited
™ Colour names are trademarks of Bluescope Steel Limited

Early Fire Hazard Properties AS 1530-1999 DeltaTrimCorro™ - EPS-FR Panel

Index	Test Range	External Top Skin
Ignitability	0-20	0
Spread of Flame	0-10	0
Heat Evolved	0-10	0
Smoke Developed	0-10	2

DeltaTrimCorro™ Fixing Details

Crest fixing only. One fixing every second crest

Panel Thickness (mm)	Fixing into Steel	Fixing into Timber
75	Tek 14 x 175 Hex Head Screw	T17 14 x 175 Hex Head Screw
100	Tek 14 x 200 Hex Head Screw	T17 14 x 200 Hex Head Screw
125	Tek 14 x 230 Hex Head Screw	T17 14 x 230 Hex Head Screw
150	Tek 14 x 260 Hex Head Screw	T17 14 x 265 Hex Head Screw
175	Tek 14 x 300 Hex Head Screw	T17 14 x 300 Hex Head Screw
200	Tek 14 x 300 Hex Head Screw	T17 14 x 300 Hex Head Screw

Use Cyclone Plate and Neo Washer on each fixing

Upon Installation the overlap needs to be stitch screwed or riveted every 300mm.

* Please refer to the web page for the available colour range, paint finishes and relevant warranty conditions.



DeltaSingle™

DeltaSingle™ allows you to create the perfect outdoor entertaining area that enhances your lifestyle, and adds value to your property.

- The new DeltaLum™ LED lighting system and DeltaSkylight are easily to install as components of the DeltaSingle™ roofing system
- Cost effective and stylish patio system when combined with DeltaBeam™
- Clip-together modules make DeltaSingle™ perfect as a DIY project
- 300mm wide roof modules allow for easy handling and fast installation
- Deep roofing profile creates strength and allows for greater spans

- Ceiling profile combines the elegance of VJ panelling with a clean, modern appearance
- Available in popular high-gloss colours to complement your house
- Written 20 Year Warranty for true peace of mind

* Download technical data information from the Delta Panels™ website





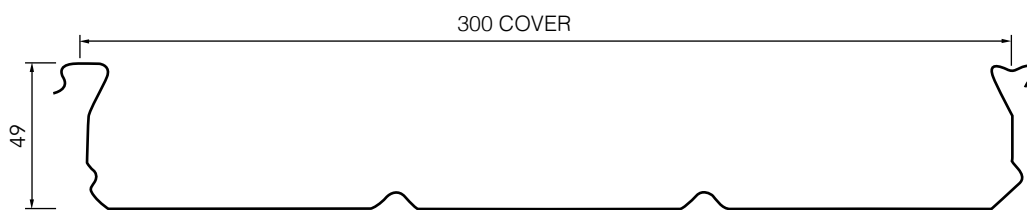
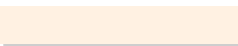
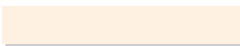

Figure - Sheeting Profile



Material:

G550 0.48 BMT steel to AS 1397

Colour Range - DeltaSingle™

Roof Colour		Ceiling Colour		
	Off White		Off White	●*
	Smooth Cream		Smooth Cream	●*
	Monolith		Off White	●*

* Note: DeltaSingle™ colours are 80% gloss level on the ceiling, standard gloss level on the roof.



DeltaSingle™

1. Minimum roofing slope to be 1°.
2. The minimum fixing requirements are 3/14g screws per sheet per support.
3. Allowable deflection limit for wind loading is span / 50.
4. Maintenance load of 0.5kN has been allowed for.
5. DeltaSingle™ is classified as a non-trafficable roof.
6. Maximum allowable overhang of sheeting is 30% of the adjacent span or 900mm, whichever is lesser.
7. 'Roof Span' is the maximum spacing of supports for sheeting.
8. Design wind class is to be determined in accordance with AS 4055:2021, Wind Loads for Housing.
9. The structural adequacy to any existing structure to which the sheeting and/or beam is to be attached, must be checked by an Engineer.
10. Any side of new roofing with more than 50% clear area of ground to sheeting blocked, is considered to be an enclosed wall.

Allowable Span (mm) for 0.48 BMT Delta Single in non-cyclonic regions

Wind Class	Single-Span				Multi-Span			
	Cp,n				Cp,n			
	0.5	0.7	1	1.2	0.5	0.7	1	1.2
Patio Type	1P	1	2+4	3	1P	1	2+4	3
N1	5340	5130	4550	4280	6330	5820	4820	4370
N2	5240	4910	4060	3650	5850	4900	4050	3650
N3	4630	3850	3130	2820	4620	3850	3130	2820
N4	3720	3060	2500	2250	3710	3060	2490	2250
N5	2970	2460	2010	1830	2970	2450	2010	1830

Allowable Span (mm) for Delta Beams - Roof panel span of 6.5m with 1m overhang

Wind Class	N2	N3	N4	N5
100x1.0 Beam	3620	2820	2970	2300
150x1.2 Beam	4770	3640	3850	2920
200x1.2 Beam	5500	4110	4370	3220
250x1.6 Beam	7960	6500	6780	5270
300x1.6 Beam	8630	7000	7380	5490

Limits For Using Type 1P Awning Classification

Following are the dimensional requirements for using Type 1P awning classification, which has 1 partial wall.

- For awning dimensions, refer to figure 1.
- Awning is to be attached one side only to an existing building.
- Awning pitch "α" is to be between 1° and 10°.
- Slope of the awning is to be normal to the attached wall.
- Minimum hc = 0.05 x d
- Maximum hc = 1.0 x d
- Maximum hc/wc to be as per Table 1.
- Maximum blockage under the roof parallel to the attached wall is to be 56% of the projected area.
- Awnings attached one side that do not comply with the above are to be classified as Type 1.

DeltaDualCore™ Panels

Product Details

DeltaDualCore™ Panels utilise a unique combination of core materials, allowing the panel to retain the structural and aesthetical benefits of insulated panels, while still conforming to non-combustibility requirements of Part 3.7 of the National Construction Code (NCC) 2022 Volume Two.

Product Features

- Engineer Certified to conform to the non-combustible requirements for Class 10 Buildings with 900mm of the boundary line.
- Available in both DeltaTrim™ & DeltaOrb™ Top sheets
- Refer to the Colour Chart for all details regarding the range of available colours
- Offers a practical solution to building Patios and Awnings and Patios along the boundary line.
- DeltaDualCore™ Panels are covered by Codemark Certificate CM40330 Rev 1
- DeltaDualCore™ Panels is covered by Innovated Patent Number 2021104435

Product Range

Steel Skin Details	Top Skin	0.42mm / G550 AZ150
	Bottom Skin	0.60mm / G300 Z275
Core Material Options	- SL Grade Polystyrene - Fire Retardant Grade - Mineral Wool - MW - 900 minimum	
Thermal Conductivity	Minimum 0.0363 W/mK @ 23.0 C	
Adhesive	Thermosetting two-part adhesive	
R Value @22.5°C	75mm Panel	2.08
	100mm Panel	2.78
	125mm Panel	3.48
	150mm Panel	4.17
Sheet Coverage	1000mm	
Density	Average density for a 6.0 metre panel is 30.8kg/m ³	
Length (mm)	Cut to length. Min. of 1800mm	
Thickness (mm)	75, 100, 125, 150	
Weight (kgs/m²)	75mm Panel	13.9
	100mm Panel	14.7
	125mm Panel	16.7
	150mm Panel	18.7
Minimum Roof Pitch	DeltaTrim™ - 2°	
	DeltaOrb™ - 3° for Class 10 Buildings	

DELTATRIM™ - WITH DUALCORE™

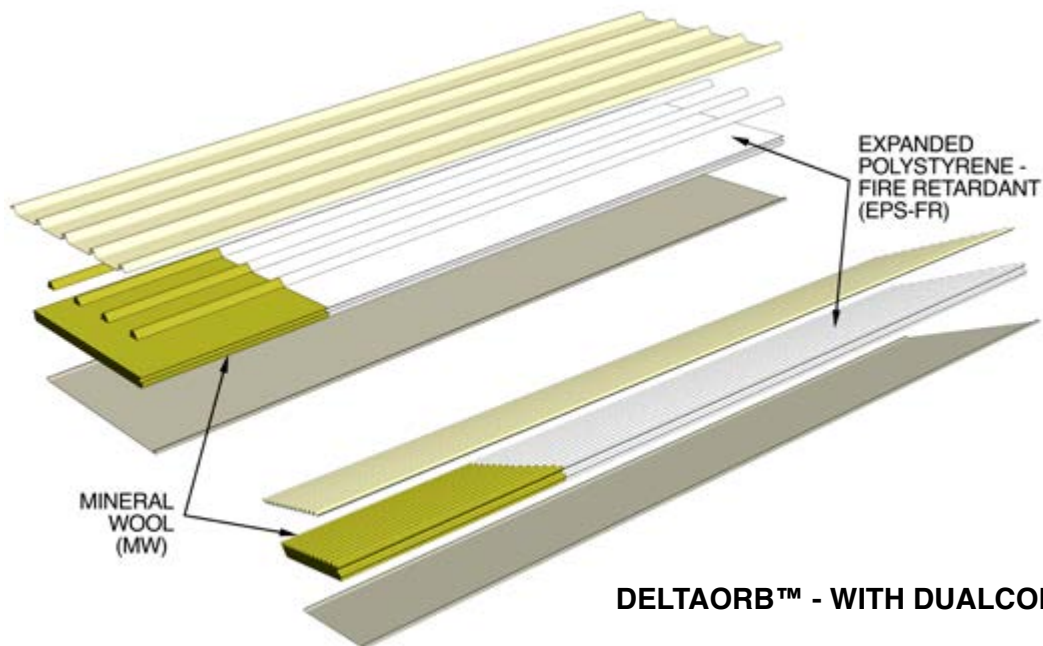

DELTAORB™ - WITH DUALCORE™



Technical Specifications

Steel Skin Details Roof	Top Skin	0.42mm / G550 AZ150
	Bottom Skin	0.55mm / G300 Z275
Max. Skin Temperature	78°C Dry Heat	
Core Material Details	Mineral Wool	
Thermal Conductivity	0.042 W/mK @23.0°C	
Core Density	100kg/m ³	
0.6mm Skin Weight (kg/m²)	75mm Panel	18.50
	100mm Panel	21.00
	125mm Panel	23.50
	150mm Panel	26.00
R Value	75mm Panel	2.50
	100mm Panel	3.30
	125mm Panel	4.20
	150mm Panel	5.00
Certificate of Conformity	CM40435	
Sheet Coverage	1000mm - Roof	
Length (mm)	Cut to Length Min of 1800mm	
Length Tolerance (mm)	5mm+/-	
Thickness (mm)	75, 100, 125, 150	
Flatness Standards	0.55mm	Surface deformations can be apparent to the naked eye when observed in certain lighting conditions

Fire Test Performance

Combustibility Test AS 1530.1-1994

CSIRO Report no. FNC12604 dated 8/7/2020 tested five (5) samples of the Delta Panels supplied mineral wool sample and certified that the material is NOT deemed combustible according to the criteria specified in clause 3.4 of AS 1530.1-1994.

Sotera - FireX™ Car Port System

The Sotera report A21007 J005 - DeltaFireX Car Port System FER dw rev 1-4 confirms that the FireX™ Car Port System meets the performance requirements of P2.3.1(a) Volume 2, NCC 2022 Amendment 1 when installed in accordance with the DeltaFireXRoof Brochure version V24.07.03 and section 4.4 of their report as a Class 10a structure (car port) attached or adjacent to a Class 1a building positioned directly adjacent to the site boundary (i.e.) less than 900 mm from the site boundary)

Sotera - Delta MW and EPS-FR Awning & Patio Roof System

The Sotera report A21007 J004 - Delta MW and EPS-FR Awning and Patio Roof System FER dw rev 1-4, confirms that the Mineral Wool & EPS-FR Awning & Patio Roof System meets the performance requirements of P2.3.1(a) Volume 2, NCC 2022 Amendment 1 when installed in accordance with the Delta Mineral Wool Panels Brochure version V24.07.03 and section 4.4 of their report as a Class 10a structure (car port) attached or adjacent to a Class 1a building positioned directly adjacent to the site boundary (i.e.) less than 900 mm from the site boundary)

DELTATRIM™ - MINERAL WOOL

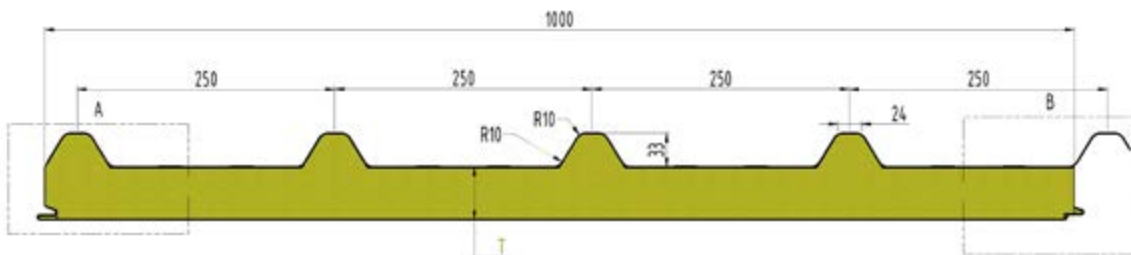

DELTAORB™ - MINERAL WOOL

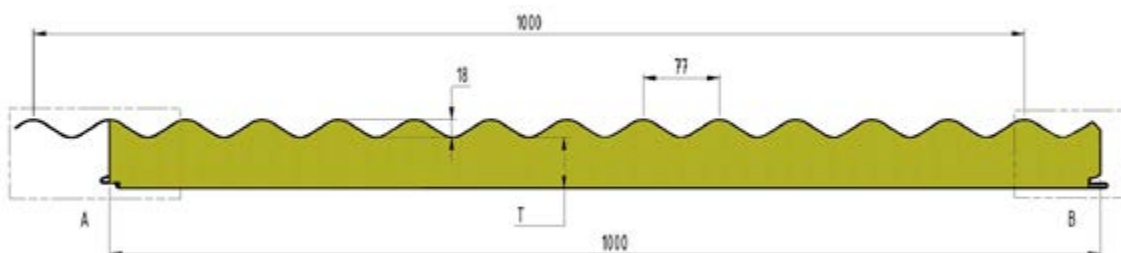

DELTA PATIO & AWNING RANGE

DeltaDualCore™ Panels

- For Awning and Patio Roofing that finishes within 900mm of the boundary line.

Panel Layout

- Design Configuration

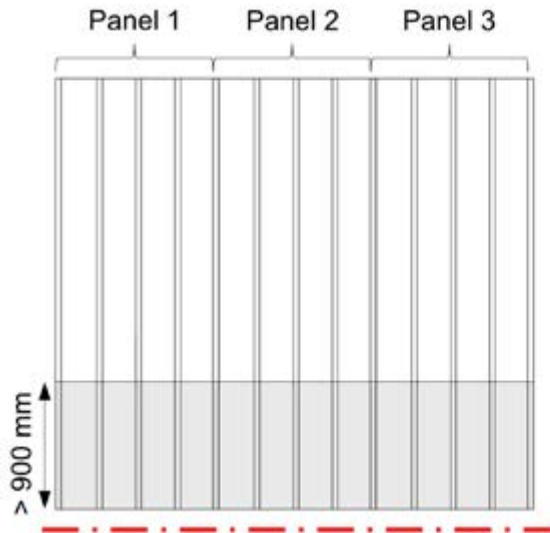

NOT DRAWN TO SCALE

- Mineral Wool
- Expanded Polystyrene – Fire Retardant (EPS-FR)
- Site boundary

DeltaFireXRoof™ Mineral Wool Side Panel

- For Awning and Patio Roofing that finish within 900mm along the boundary line.

Panel Layout

- Design Configuration

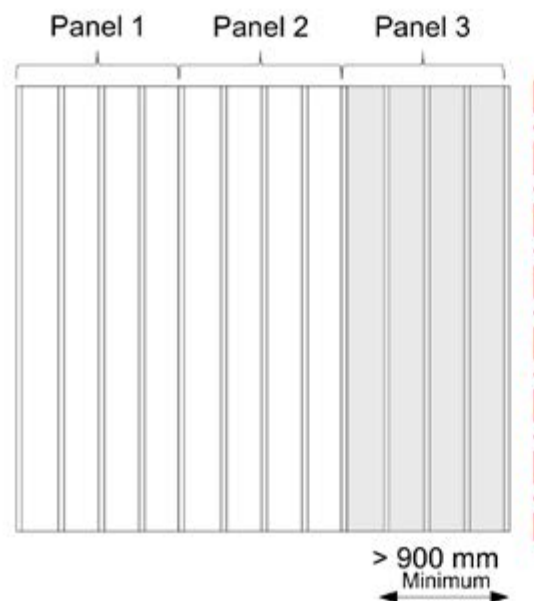

NOT DRAWN TO SCALE

- Mineral Wool
- Expanded Polystyrene – Fire Retardant (EPS-FR)
- Site boundary

DELTA PATIO & AWNING RANGE

DeltaFireXRoof™ Mineral Wool Panel - Complete Coverage

- For Awning, Patio and Car Port Roofing that finish within 900mm of any boundary line.

Panel Layout

- Design Configuration

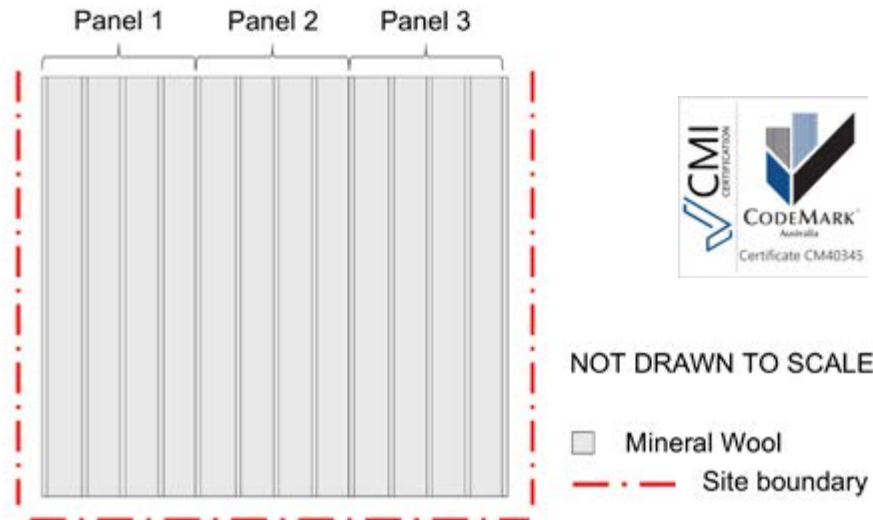

DeltaDualCore & DeltaFireXRoof™ Mineral Wool Side Panel

- For Awning and Patio Roofing that finishes within 900mm of the boundary line on 2 sides of the structure.

Panel Layout

- Design Configuration

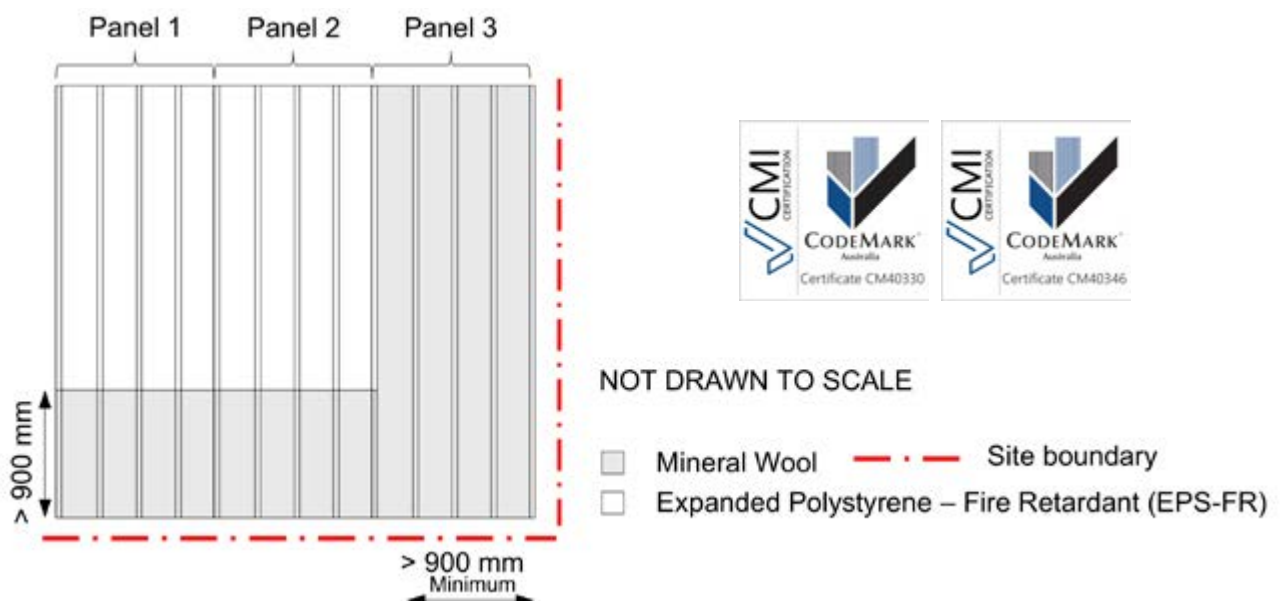

BUSHFIRE ATTACK LEVEL - BAL

Roof Structures



DELTA PANEL RANGE OF BAL ACCREDITED ROOF PANELS

PRODUCT	BAL - 12.5	BAL - 19	BAL - 29	BAL - 40	BAL - FZ
DeltaTrim-MW	*	*	*	*	-
DeltaOrb-MW	*	*	*	*	-
DeltaCorroCorro-MW	*	*	*	*	-
DeltaTrimTrim-MW	*	*	*	*	-
DeltaTrimCorro-MW	*	*	*	*	-
DeltaTrim-TPC	****	****	****	-	-
DeltaOrb-TPC	****	****	****	-	-
DeltaTrim-EPS-FR	*****	*****	*****	*****	-
DeltaOrb-EPS-FR	*****	*****	*****	*****	-
DeltaSingle	*	*	*	*	*

* Non-Combustible as Determined by AS1530.1:2018

**** CSIRO report FSZ 2411 Dated 21-12-2023, FCO 3545 Dated 29-04-2024

***** BRANZ Fire Assessment Report FC10893-01-02- C1, Dated 15-8-2022

Full Test Reports are published on our Web page



BUSHFIRE ATTACK LEVEL - BAL

External Wall Structures



DELTA PANEL RANGE OF BAL ACCREDITED WALL PANELS

PRODUCT	BAL - 12.5	BAL - 19	BAL - 29	BAL - 40	BAL - FZ
DeltaCool-MW	*	*	**	**	**
DeltaCool-TPC	***	***	***	-	-
DeltaCool-EPS-FR	*****	*****	*****	-	-

* Non-Combustible as Determined by AS1530.1:2018

** BRANZ FR10430-001 Fire Test Report in accordance with AS1530.2:2014 with a FRL rating of -/120/60

*** CSIRO report FSZ 2373, Dated 9-6-2023. CodeMark Certificate of Compliance CM40365

***** BRANZ Fire Assessment Report FC10893-01-02- C1, Dated 15-8-20223. CodeMark Certificate of Compliance CM40365

Full Test Reports are published on our Web page



DELTA PATIO & ROOFING RANGE



SITE SPECIFIC WARRANTIES UP TO 25 YEARS AVAILABLE UPON REQUEST

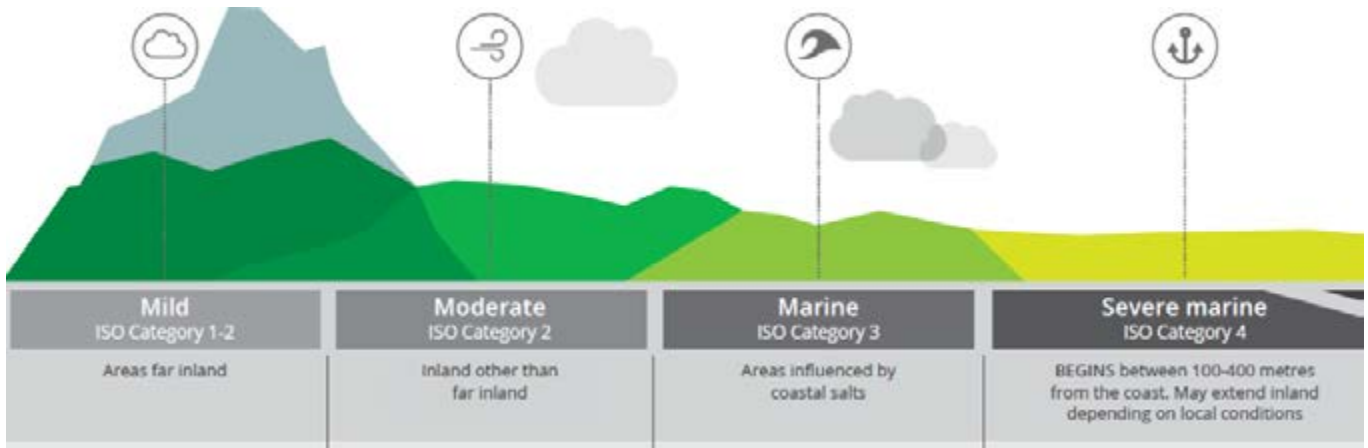

DeltaMax™ is a steel substrate that provides greater corrosion resistance and a longer working life in demanding environmental conditions.

Product Range

- All DeltaMax™ Roof panels are available in - DeltaTrim™ with Expanded Polystyrene Fire Retardant Grade (EPS-FR), Thermosetting Phenolic Composite (TPC), Mineral Wool (MW) & DualCore (DC).
- All DeltaMax™ Roof panels are available in - DeltaOrb™, DeltaCorroCorro™, DeltaTrimTrim™ & DeltaTrimCorro™ with Expanded Polystyrene Fire Retardant Grade (EPS-FR), Thermosetting Phenolic Composite (TPC), Mineral Wool (MW) & DualCore (DC).
- All DeltaMax™ Wall panels are available in - DeltaCool™ & DeltaSecretFix™ with Expanded Polystyrene Fire Retardant Grade (EPS-FR), Thermosetting Phenolic Composite (TPC), Mineral Wool (MW) & DualCore (DC).
- All Receiver Channels along with the full suite of associated flashings are available in DeltaMax™.
- SurfMist only, with other colours on request.
- Site specific warranties up to 25 years are available.

Recommendations

- Patios, Pergolas and Carports near coastal conditions or canals
- Commercial buildings near coastal conditions
- Portable Buildings
- Spray Booths
- Wineries
- Industrial buildings near corrosive elements

DeltaMax™ Specifications

Steel Skin Details	Top Skin	Bottom Skin
DeltaTrim™	0.42mm / G550 ZM240	0.60mm / G300 ZM240
DeltaOrb™	0.42mm / G550 ZM240	0.60mm / G300 ZM240
DeltaCorroCorro™	0.42mm / G550 ZM240	0.42mm / G550 ZM240
DeltaTrimTrim™	0.42mm / G550 ZM240	0.42mm / G550 ZM240
DeltaTrimCorro™	0.42mm / G550 ZM240	0.42mm / G550 ZM240
DeltaCool™	0.60mm / G300 ZM240	0.60mm / G300 ZM240
DeltaSecretFix™	0.60mm / G300 ZM240	0.60mm / G300 ZM240
Receiver Chanel	1.0mm / G550 ZM240	
Flashings	0.55mm / G550 ZM240	
ISO Categories	3-5	
Metallic Coating Weight (gms)	240	
Example Warranty (Site Specific)	ISO 4, Calm	
	Perforation	25 Years
	Flake / Peel	20 Years
	Excessive Fade	20 Years

DELTA PATIO & ROOFING RANGE

Product Range

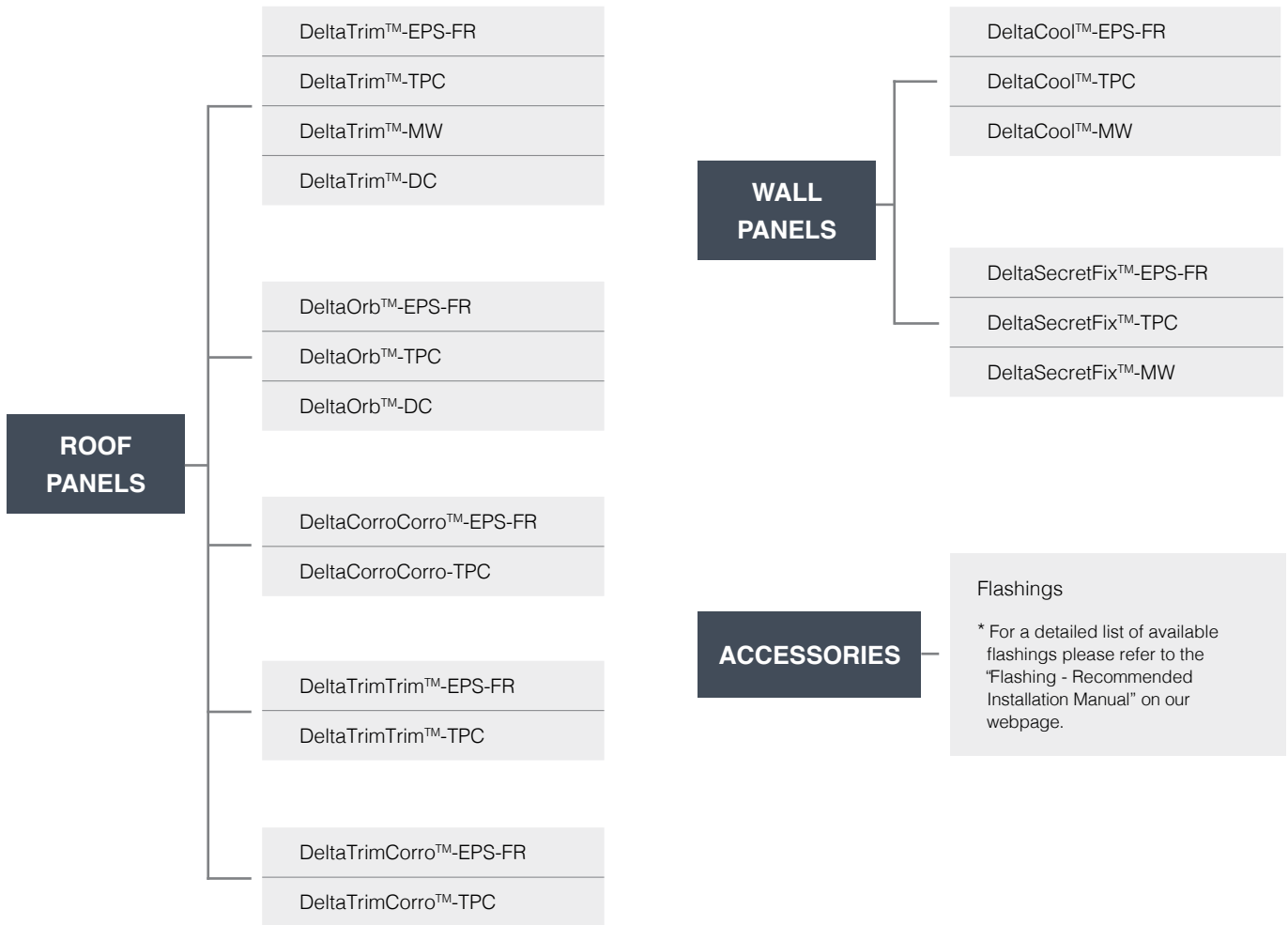

Ongoing Maintenance

To minimise the onset of corrosion on products installed in sheltered areas, or in areas unwashed by natural rainfall must be washed down every six months.



ColorCote® and Magnaflow™ are both trademarks of Fletcher Steel Ltd.

ColorCote® imagery and graphics are copyright and intellectual property of Fletcher Building Limited

DeltaMax™, DeltaTrim™, DeltaOrb™, & DeltaCorroCorro™ are all trademarks of Delta Panels Pty Ltd

DELTA PATIO & ROOFING RANGE

ROOFING ACCESSORIES

Flashing and Rainwater Goods

To ensure the highest standards Delta Panels manufacture in-house a wide range of flashings and rainwater accessories.

Please refer to our Flashings - Recommended Installations Manual to see the extensive range of standard flashings we provide. We can also supply one-off designs to suit any application.

A range of gutter profiles are also available, with a selection of downpipes to suit.

All flashings and gutters are available in DeltaMax.

Flashings unless otherwise noted are made from 0.55mm steel.



Roofing Accessories

Delta Panels offers a one-stop-shop for the complete range of roofing accessories, including foam infill strips, butyl rubber adhesive tape and sealants.



Fasteners

Please refer to the screw selection table in the Handling and Installation Manual to select the correct fastener for the panel type and thickness. For any projects that must comply with Factory Mutual certifications, please refer to the Factory Mutual Approvals web page which lists the approved fastener system specific to each panel type.

Screw Types

Main Fasteners with Cyclone Plate and Washer

Metal Tek - Fixing | **Fixing into Steel Beams up to 12.5mm**

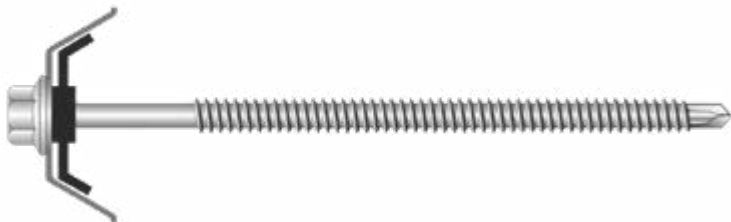

T17 - Fixing | **Fixing into Timber Beams**



Secondary Fasteners

Tek M13 x 25mm



Tek M10 x 16mm



Dome Rivet 73 AS 4.3



DELTA PATIO & ROOFING RANGE

Screw Selection Tables



DeltaTrim™

Minimum Class 3 - must be HEX Head	Steel Beam	Timber Beam	Minimum Class 3 - must be HEX Head	Steel Beam	Timber Beam
50mm	135mm	125mm	150mm	230mm	230mm
75mm	150mm	150mm	175mm	260mm	265mm
100mm	175mm	175mm	200mm	260mm	300mm
125mm	200mm	200mm			

DeltaOrb™

Minimum Class 3 - must be HEX Head	Steel Beam	Timber Beam	Minimum Class 3 - must be HEX Head	Steel Beam	Timber Beam
50mm	115mm	125mm	150mm	200mm	230mm
75mm	135mm	150mm	175mm	230mm	265mm
100mm	150mm	175mm	200mm	260mm	300mm
125mm	175mm	200mm			

DeltaCorroCorro™

Minimum Class 3 - must be HEX Head	Steel Beam	Timber Beam	Minimum Class 3 - must be HEX Head	Steel Beam	Timber Beam
75mm	115mm	125mm	175mm	200mm	230mm
100mm	135mm	150mm	200mm	230mm	265mm
125mm	150mm	175mm	225mm	260mm	265mm
150mm	175mm	200mm	250mm	300mm	300mm

DeltaTrimTrim™

Minimum Class 3 - must be HEX Head	Steel Beam	Timber Beam	Minimum Class 3 - must be HEX Head	Steel Beam	Timber Beam
75mm	200mm	200mm	150mm	260mm	265mm
100mm	230mm	230mm	175mm	300mm	300mm
125mm	230mm	230mm	200mm	300mm	300mm

DeltaTrimCorro™

Minimum Class 3 - must be HEX Head	Steel Beam	Timber Beam	Minimum Class 3 - must be HEX Head	Steel Beam	Timber Beam
75mm	175mm	175mm	150mm	260mm	265mm
100mm	200mm	200mm	175mm	300mm	300mm
125mm	230mm	230mm	200mm	300mm	300mm



POST & BRACKET OPTIONS

Base Plate

- 1 x G300 4mm thick Internal Bracket
- 1 x M12 Gal Concrete fixing to footing
- 1 x M12 Gal Hex Head Bolt/Nut/Washer post to bracket
- Available in Steel and Aluminium

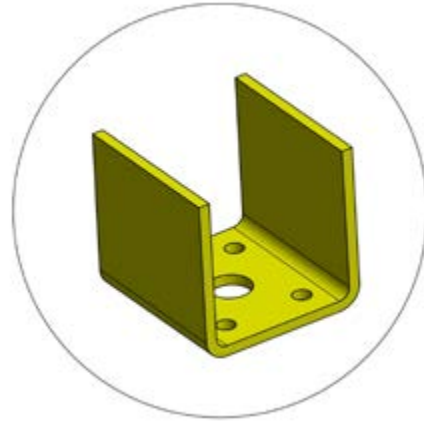

Base Plate

- 1 x G300 4mm thick Bracket welded to a 4mm CFW base plate
- 1 x M12 Gal Hex Head Bolt/Nut/Washer, post to bracket
- 2 x M12 Gal Concrete fixing to footing
- Available in Steel and Aluminium

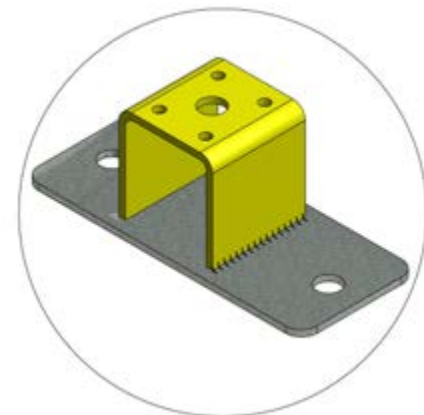

Post to Beam

- 2 x M12 Gal Hex Head Bolt/Nut/Washer, beam to post
- 2 x Anti-crush sleeve
- Available in Steel and Aluminium





POST & BRACKET OPTIONS

Base Plate

- 1 x 10mm CFW thick Base Plate with welded G300 4mm thick upright support angles
- 2 x M12 Gal Hex Head Bolt/Nut/Washer, post to bracket
- 4 x M12 Gal Concrete fixing to footing
- Available in Steel and Aluminium

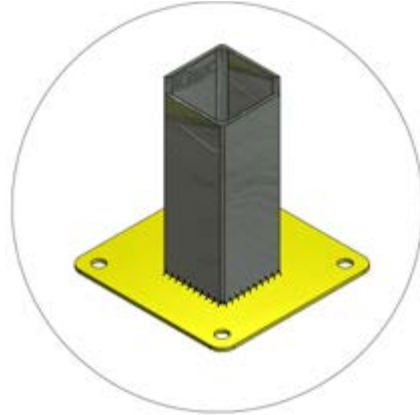

Post to Beam

- 2 x M12 Gal Hex Head Bolt/Nut/Washer, beam to post
- 2 x Anti-crush sleeve
- Available in Steel and Aluminium
- Available in the following lengths
 - 2400mm
 - 3000mm
 - 4500mm
 - 5500mm



Foot Plate Cover

- Foot plate cover to suit both Type 3 & 4, 100mm posts.
- Die-cast aluminium mould
- Powder Coated Finish
- Available in Steel and Aluminium

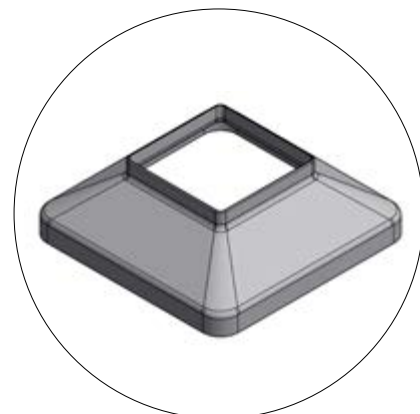



DELTABEAM™ - COASTAL RANGE



Product Details Aluminium Beam Range

A range of Aluminium Beams have been added to the DeltaBeam™ range. These beams are extruded to give a precise finished profile. They are manufactured from Aluminium Alloy 6063-T5 and designed with a 5mm Base and Top with a fluted Side Wall of 3mm to provide for maximum spanning capacity. They are specifically designed to be used in Coastal & Marine Environments to combat the corrosive nature of exposure to saltwater.

Available in both Off White & Ebony as a standard colour, though a wide range of powder coated colours are available upon request.

DeltaBeam™ Specifications Aluminium Beam Range		
	150	200
Base Metal Thickness Side Walls	3mm	3mm
Base Metal Thickness Base & Top	5mm	5mm
Mass	4.2kg/lm	5.0kg/lm

* Refer to Delta Span Tables for design and spanning details.

Product Features

- Available in both 150mm & 200mm Beam sizes
- Die-cast aluminium end-caps to suit
- Wide range of powder coated finishes available
- Available in the following lengths
 - 4000mm - 5000mm - 6000mm
 - 7500mm - 9000mm

Standard Colour		
	150	200
Off White	•	•
Ebony	•	•

DeltaBeam™ is manufactured in 80% gloss colours

DeltaBeam™ Dimensions

Aluminium Beam Range

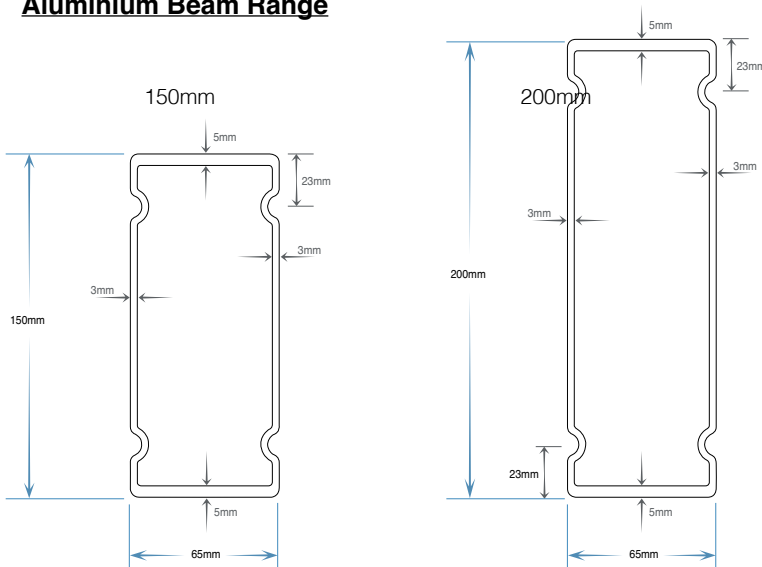

Aluminium Beam

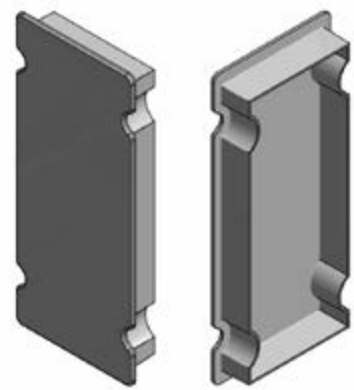

End Caps



DeltaXtremeBeam

Product Details

DeltaBeams™ are available in 5 sizes allowing for maximum design flexibility. They are engineered and tested to comply with Australian Standard AS 1397/G550. All DeltaBeams™ are manufactured from strong high tensile steel in a range of contemporary colours allowing for long unsupported spans.

DeltaBeam™ Specifications

Manufactured from high tensile steel, DeltaBeam™ is engineered and tested to comply with Australian Standard AS 1397. Major components are made from strong high tensile steel, while the fixings and brackets are galvanised for a long, useable life.

DeltaBeam™ Specifications					
	100	150	200	250	300
Base Metal Thickness	1.0mm	1.2mm	1.2mm	1.6mm	1.6mm
Yield Strength	550MPa	550MPa	550MPa	550MPa	550MPa
Mass	4.1kg/m	5.7kg/m	7.8kg/m	10.4kg/m	11.7kg/m

* Refer to Delta Span Tables for design and spanning details.

Product Features

- Our in-house powder coating line can offer a wide range of contemporary colour finishes
- DeltaXtremeBeam™ now available in 250mm and 300mm for extra long unsupported spans
- Two-piece construction giving extra strength and spanning
- Cut to length
- Has a wide range of colour-matched accessories for quick and easy onsite assembly
- All DeltaBeams™ are manufactured with a standard 20 year warranty with site specific warranties available on request. Please refer to the warranty conditions as outlined on our web page.



Standard Colours					
	100	150	200	250	300
Off White	•	•	•	•	•
Ebony	•	•	•	•	•

DeltaBeam™ is manufactured in 80% gloss colours

DeltaBeam™ Dimensions

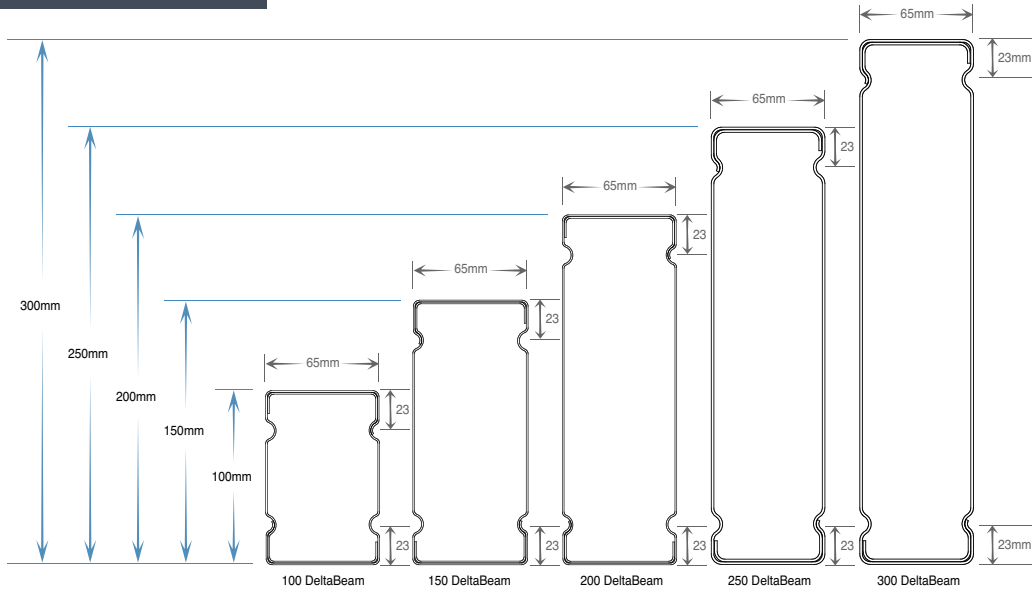



▶ DeltaSkylight™

The installation of Skylights is always an excellent way to provide natural daylight to any enclosure. Delta Panels™ produces a range of PVC skylights to suit all of their roofing products.

When combined with DeltaLum™ LED lighting, the patented combination skylight systems allows for natural light during the day and controlled lighting in the evenings.

DeltaSkylight™ systems are thermally efficient and their light weight offers ease of installation. Any concerns regarding overhead impact from being in an uncovered area is eliminated as the PVC material is durable and robust.

Combining the benefits of PVC skylighting with the patented integrated DeltaLum™ lighting system makes the DeltaSkylight™ range the logical choice to enhance the all-round functionality of any deck or patio setting.



- Available in 4 different combinations to suit DeltaTrim™, DeltaOrb™, DeltaSingle™ & DeltaCool™.
- Conforms to the Australian Standards, AS 1562.3-2006 & AS 4256.5-2006
- Covered by Australian Patent No. 2017298014
- Remote controllers
- Low Voltage LED driver
- Written 12 Month Warranty
- A range of light colours available
- Dimmable
- SAA approved electrical components
- No loose hanging wires and unsightly brackets

DELTA PATIO & ROOFING RANGE

Versatile Design Feature



UNIQUE COMBINATION OF LED LIGHTING & SKYLIGHT

The Skylight and LED lighting patented combination skylight system allows for natural light during the day and controlled lighting in the evenings. DeltaSkylight™ systems are thermally efficient and their light weight offers ease of installation. Any concerns regarding overhead impact from being in an uncovered area is eliminated as the PVC material is durable and robust.

Combining the benefits of PVC skylighting with the patented integrated DeltaLum™ lighting system makes the DeltaSkylight™ range the logical choice to enhance the all-round functionality of any deck or patio setting.

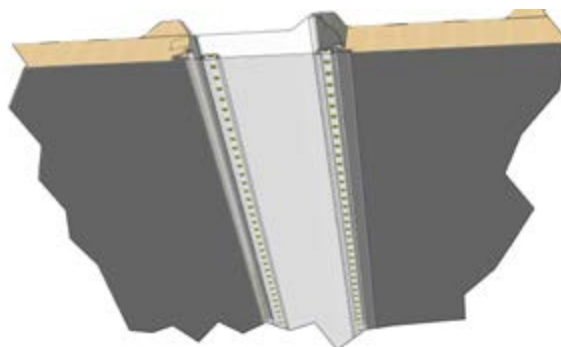
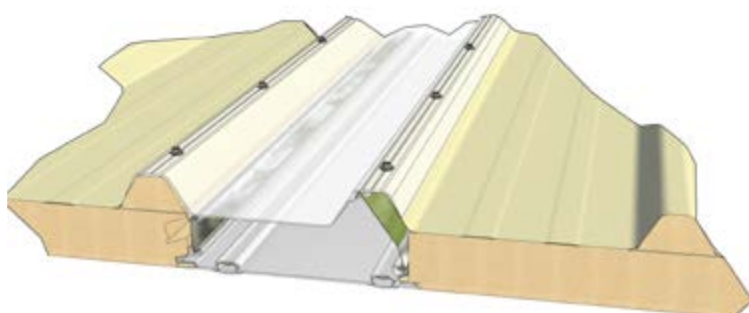



Skylight Options

DeltaLum™ lighting incorporates a translucent PVC extruded skylight when combined with a unique patent protected inbuilt LED lighting system, allows the patio and adjoining rooms to be bright both during the day and into the evening.

DeltaCool™ skylight can also be utilised as a ceiling or wall in an internal room as a feature lighting fixture.

DeltaTrim™

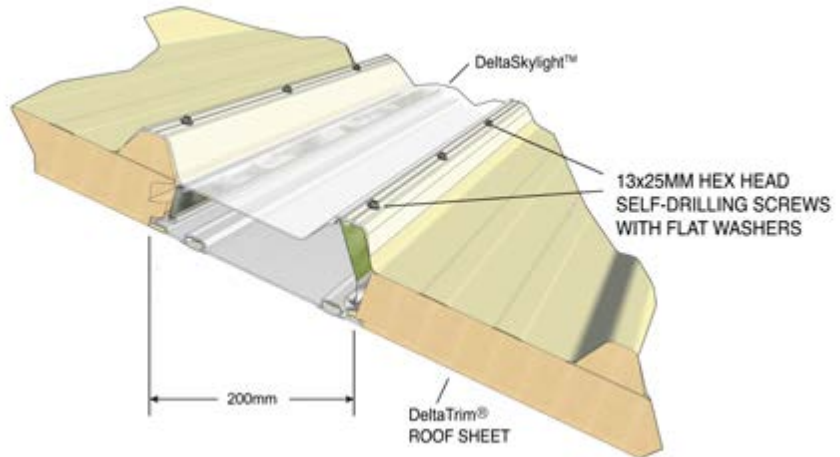

DeltaOrb™

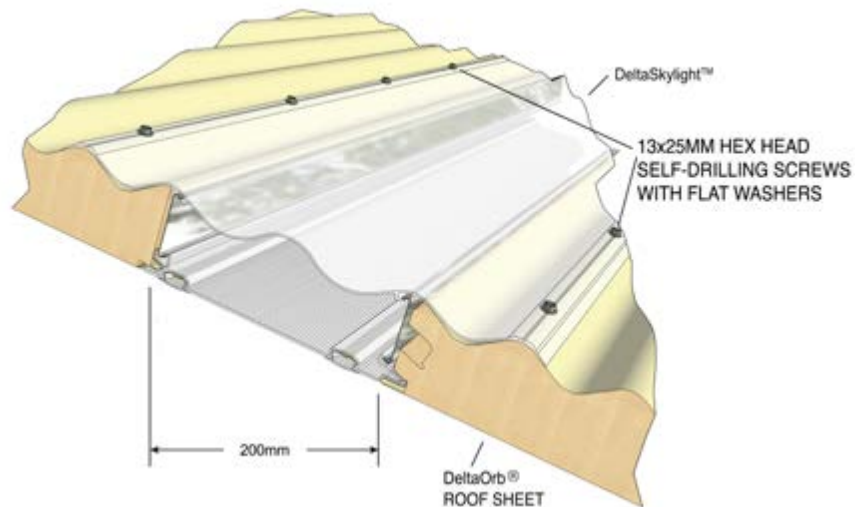

DeltaCool™

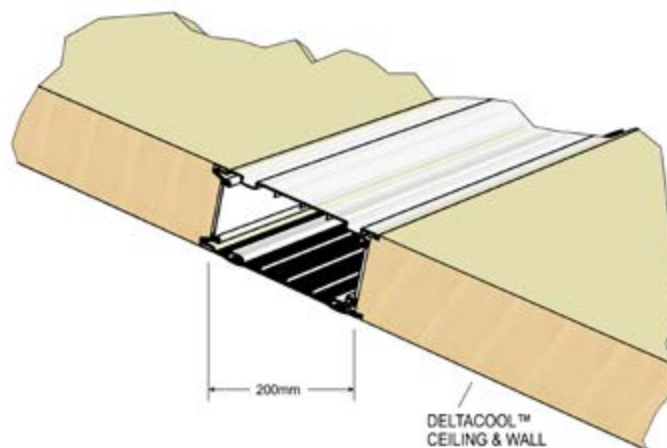



DeltaSkylight™ LED Light-Assemblies

Product Details

The DeltaLum™ LED light system in conjunction with the DeltaLum Led Skylight are covered by the Australian Innovation Patent Application No. 20181010435. The uniquely innovated design allows for natural daylight to illuminate the patio area, while at night time the system operates as a fully functioning lighting system.

DeltaCool™ skylight can also be utilised as a ceiling or wall in an internal room as a feature lighting fixture.

DeltaTrim™ - Skylight Assemblies

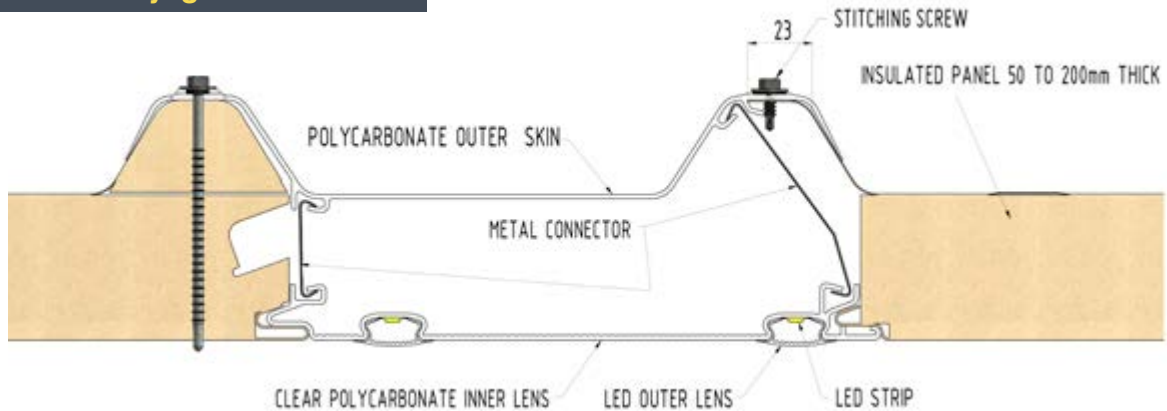

DeltaOrb™ - Skylight Assemblies

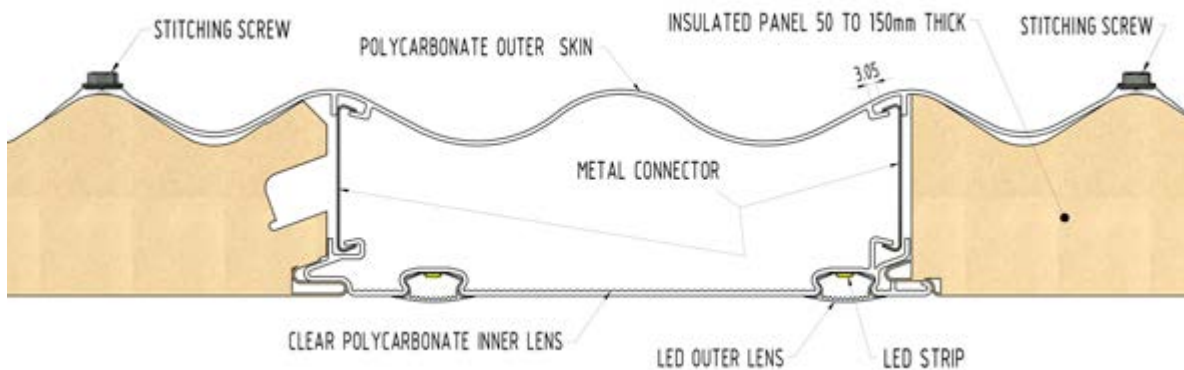

DeltaCool™ - Skylight Assemblies

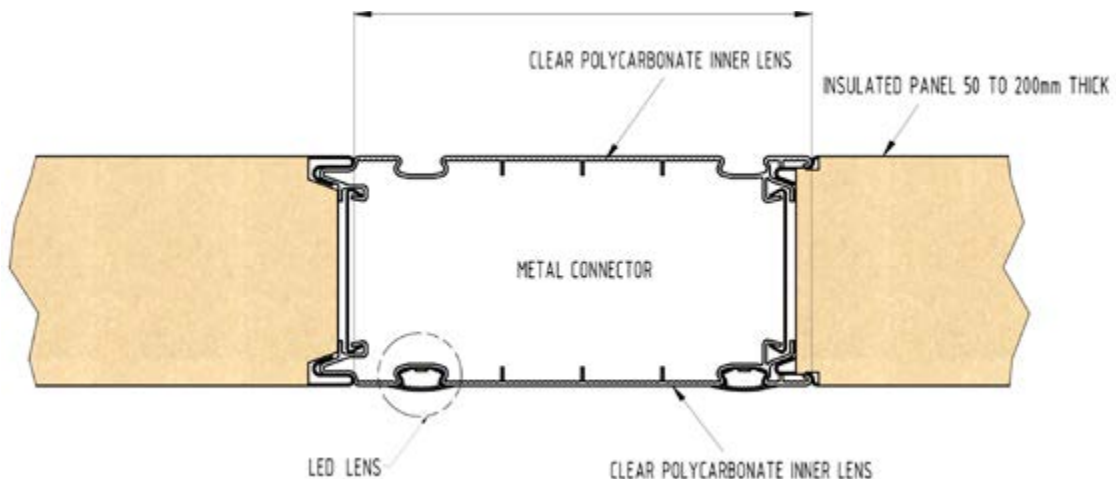



DeltaLowProfile Light

Product Details

The DeltaLowProfile™ Light is specifically designed for use in insulated panels with 2 sizes available allowing for maximum design flexibility. The wafer-thin profile measures just 20mm this creating a minimal recess when mounted in a laminated panel.

We do not recommend the installation of standard shop bought downlights which measure more than 20mm in profile, as these may compromise the structural integrity of the laminated panel.

Product Features

- Available in 2 sizes 120mm & 170mm
- 120mm available lighting colour options are Warm White & Cool White
- Aluminum & Acrylic Construction
- Durable Powder Coated exterior trim
- Round feature with integral edge-lit LED strip
- Steel spring clip for easy installation
- Polycarbonate Lens provides even illumination
- Strong thread-lock connectors for various cable length combinations.
- Low Voltage Power source
- Dimmable
- SAA Certified

DeltaLowProfile Specifications

Manufactured from aluminum and acrylic, and finished with a durable powder coated trim the DeltaLowProfile™ lights are designed for a long, useable lifespan.

DELTALOWPROFILE™ LIGHT SPECIFICATIONS

	DLP120	DLP170
Ceiling Cut Out	100mm	150mm
Exterior Diameter	120mm	170mm
Apature Diameter	83mm	133mm
Height	20mm	20mm
Input Voltage	AC220-240V - Dimmable	AC220-240V - Dimmable
Light Output (Lumens)	50-70 lm/w	50-70 lm/w
Lighting Colour - Cool White	√	√
Lighting Colour - Warm White	√	x
Colour Accuracy (CRI)	71 CR(Ra)	71 CR(Ra)
Correlation Colour Temperature (CCT)	6500-7000K	6500-7000K
Protection Class	IP44	IP44
Warranty	3 year limited warranty	3 year limited warranty

DELTALOWPROFILE™ VOLTAGE DRIVER SPECIFICATIONS

	DLDR12 - Trimac Dimmer	
Input Voltage	200-240 VAC, 47-63Hz	
Output Voltage	DLP120	18-25 VDC, 300mA +/-10mA
	DLP170	30-45 VDC, 300mA +/-10mA
Finish	Aluminium Weatherproof Case	
Dimmable Range	Down to 10%	
Warranty	3 year limited warranty	



DELTA PATIO & ROOFING RANGE

Product Dimensions



DLP120



DLP170

Colour Range



Product Warranty

The DeltaLowProfile™ recess downlights have been designed and extensively tested for use in conjunction with the Delta Panels range of insulated roofing panels. Therefore allowing us to offer both a 10 year product warranty and a 3 year electrical component warranty. Any non-approved alternative downlight inserted into the roof panels will immediately void all warranties, as we are unable to guarantee that the EPS core will not be affected by any excessive generation of heat resulting in compromising the structural integrity of the panel. External lighting attached to the exterior panel skin is considered acceptable within the scope of the panel warranty.

Delta Panels through our certified Quality Management Systems is fully committed to providing our customers with high quality products. The DeltaLowProfile™ lights are covered with extensive warranty protections encompassing the paint finish, light assembly and the electrical components. Please refer to the full Warranty terms and condition as listed on our web page.



DeltaPanels™, PROUDLY OFFERS THE FOLLOWING WARRANTIES FOR THE DELTALOWPROFILE™ DOWNLIGHTS
STRUCTURAL INTEGRITY - 10 YEARS
PAINT FINISH - 10 YEARS
ELECTRICAL COMPONENTS - 3 YEARS
CONDITIONS APPLY. PLEASE REFER TO THE FULL WARRANTY PROVISIONS AS LISTED ON OUR WEB PAGE.

Product Components

DLP120 Light set consists of:-

- 2 x DeltaLowProfile Recess Light
- 2 x 6 metre lead
- 2 x 3 metre extension lead
- 2 x Trimac dimmable drivers, with 1 metre power connection lead

DLP170 Light set consists of:-

- 1 x DeltaLowProfile Recess Light
- 1 x 6 metre lead
- 1 x 3 metre extension lead
- 1 x Trimac dimmable drivers, with 1 metre power connection lead





DeltaCool™ - Coldrooms

DeltaCool™ is the perfect solution for walling applications, utilising modern Insulated Panel technologies.

- An all-in-one walling solution for energy efficient housing or cold-rooms
- Wide 1200mm panel for faster installation and less visible joints
- Impressive insulating and sound dampening properties
- Available in 3 steel thicknesses (0.6mm, 0.5mm & 0.4mm)
- Steel face finishes available in Smooth, Ribbed, Elegance, Mico-Ribbed, 5V and Single V
- Wide range of classic and contemporary colours to match any existing structure
- DeltaCool-TPC is Factory mutual accredited Class 4880, 4881 & 4882
- Written 20 year structural warranty for true peace of mind

* Download technical data information from the Delta Panels™ website



DeltaCool™ is an Insulated Wall Panel System, comprising of two pre-painted, roll-formed steel skins, bonded to an insulated core of either fire retardant grade polystyrene, polyisocyanurate, thermosetting phenolic composite or mineral wool.

Both skins have a roll-formed tongue and groove edge.

Skins are coated with an anti-bacterial paint that inhibits the growth of bacteria.

Steel Skin Details ColorBond®	Top Skin	0.40mm / 0.60mm / G300 Z275					
	Bottom Skin	0.40mm / 0.60mm / G300 Z275					
Adhesive	Thermosetting two-part adhesive						
Core Material Options	Expanded Polystyrene Fire Retardant Grade	Thermosetting Phenolic Composite		Mineral Wool			
	EPS-FR	TPC	MW				
Thermal Conductivity W/m/K		0.042	0.039	0.0365			
Core Density (kgs/m³)		13.5	36	100			
Panel Weight (kgs/m²) based on 0.6mm steel skins	50mm	10.58	11.70	-			
	75mm	10.94	12.06	18.5			
	100mm	11.30	12.43	21.0			
	125mm	11.66	12.79	23.5			
	150mm	12.02	13.15	26.0			
	200mm	12.72	13.86	-			
External Roof R Value (m².K/W) AS/NZS 4859 Parts 1 & 2:2018		Winter (15°C)	Summer (23°C)	Winter (15°C)	Summer (23°C)	Winter (15°C)	Summer (23°C)
	50mm	1.38	1.36	1.45	1.45	-	-
	75mm	1.90	1.85	2.10	2.05	2.25	2.15
	100mm	2.52	2.43	2.75	2.65	2.95	2.85
	150mm	3.69	3.56	4.05	3.90	4.40	4.20
	200mm	4.88	4.68	5.40	5.20	-	-
Factory Mutual	DeltaCool-TPC - Accredited Class 4880, 4881 & 4882						
Sheet Coverage	1200mm						
Length (mm)	Cut to length. Min. of 1800mm						
Thickness (mm)	50, 75, 100, 125, 150, 175, 200 * MW 75-150 only.						
Flatness Standards	0.40mm 0.60mm	Surface deformations can be apparent to the naked eye when observed in certain lighting conditions					

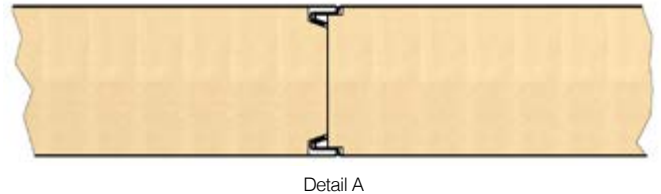
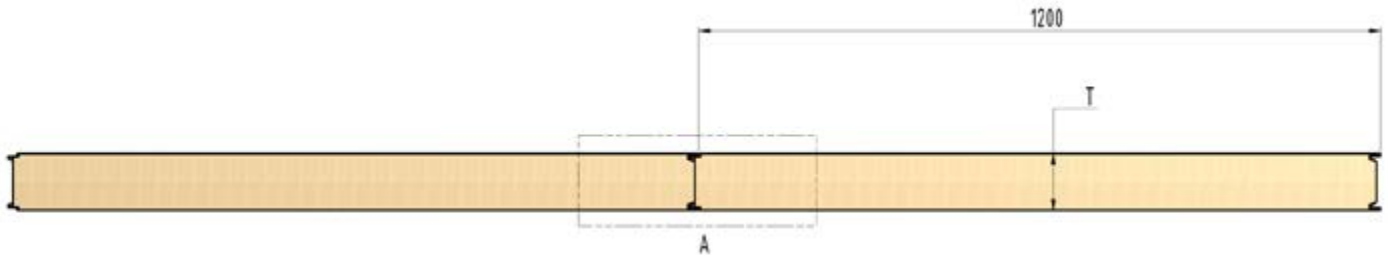

0.60mm DeltaCool-EPS-FR Bracing Capacity

Panel Height (m)	2.4	1.2*	4.8*
Kn/m	5.0	10.0	2.5
Bracing Units (BU)	100	200	50

* Figures for 1.2m & 4.8m high panels are extrapolated. It is acceptable to interpolate Bracing Capacity heights between 1.2m & 4.8m. For heights outside of this dimension range, Diaphragm Analysis is required to establish Bracing Capacity.

Shear Load Transference - Shear load is transferred by rivets into the floor / ground surface or the perpendicular walls, ceiling & roof at a rate of 1.21 kN per 4.0 mm diameter rivet.

Fixing rivets at 200mm centres complies with the 20-minute flame barrier requirements and delivers 14.5 kN of shear capacity transfer per panel (6 on each side) horizontally, and 12.1 kN per metre in vertical joints. Limited by the ability of the panel to transfer the shear.

0.6mm DeltaCool-EPS-FR Wind Pressure (kPa)

Span (mm)	Panel Thickness (mm)							
	50mm	75mm	100mm	125mm	150mm	175mm	200mm	250mm
2000	1.84	2.92	6.11	6.11	7.35	8.01	9.21	11.55
2400	1.42	2.54	5.14	5.14	6.28	6.92	7.92	9.67
3000	0.97	1.86	3.73	3.73	4.93	5.35	6.00	7.65
3600	0.70	1.39	2.68	2.68	3.84	4.28	4.77	6.05
4200	0.51	1.06	1.96	1.96	2.87	3.33	3.79	4.81
4800	0.38	0.81	1.49	1.49	2.19	2.57	2.94	3.67
5400	0.29	0.64	1.17	1.17	1.72	2.02	2.31	2.88
6000	0.22	0.50	0.94	0.94	1.38	1.62	1.86	2.32
6600	0.17	0.39	0.77	0.77	1.14	1.34	1.54	1.91
7200	0.12	0.30	0.64	0.64	0.95	1.13	1.29	1.60
7800	0.09	0.24	0.54	0.54	0.80	0.95	1.10	1.36
8400	0.07	0.19	0.43	0.43	0.69	0.82	0.94	1.17
9000	0.06	0.15	0.35	0.35	0.60	0.71	0.82	1.01
9600	0.05	0.14	0.27	0.37	0.48	0.54	0.66	0.82
10200	0.05	0.13	0.18	0.29	0.39	0.40	0.53	0.68

The above table lists ultimate wind load pressures for strength design and the pressure corresponding to a Span/150 single span deflection for 0.6mm G300 steel skins bonded to a EPS-FR core and in accordance with Serviceability Limit State criteria as per AS 1170.0 - Table C1. The designer shall determine if Span/150 deflection ratio is appropriate for intended use. Loads for a more stringent deflection ratio can be determined by linearly proportioning the loads provided. Differential thermal effects are not incorporated in the loads provided.

Coldroom Accessories

Insulated Doors

Delta Panels™ offers a wide range of Insulated Doors to complete your next cold-room project. As the weakest link in a cold-room, it is critical that a quality door is used to maintain thermal efficiency.

With a range of sizes and styles available, rely on Delta Panels™ for your next Insulated Door solution.

Fixings

Delta Panels™ stocks all of the fixings required to complete your next DeltaCool™ job, including rivets and embossed washers.

& More!

Delta Panels™ is always adding new products to our range. Contact us today to see how we can help you!

Aluminium Extrusions

Complete your next DeltaCool™ job with a full range of Aluminium Extrusions.

Options include:

- Angles in a range of sizes and finishes
- Channels in a range of styles, sizes and finishes
- Coving, including many styles such as Arrowhead
- Available in powder coated and clear finishes

Suspension Kits

A range of suspension kits are available through Delta Panels™. Kits are offered in a range of sizes and styles. Contact us for more information

We Are Members of IPCA



All Purpose Service Support Bracket

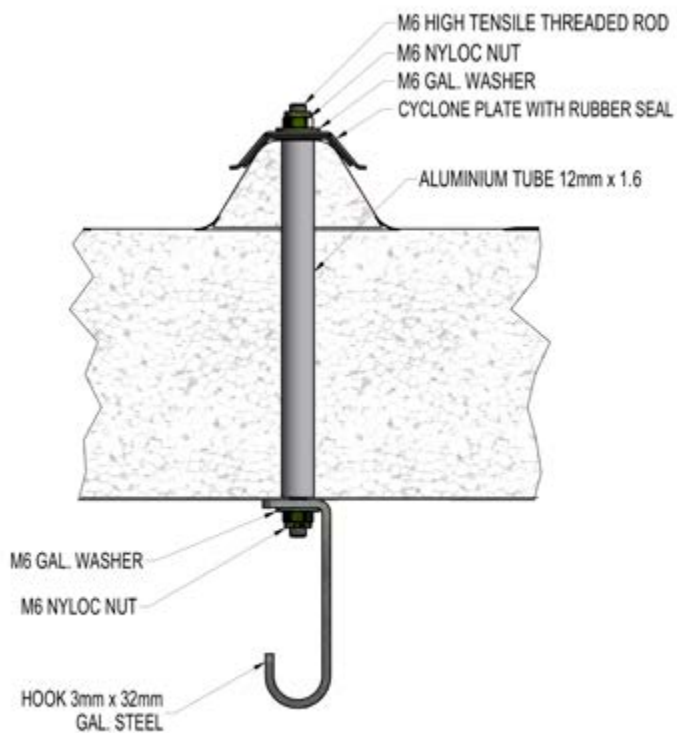

Roof Suspension Kit

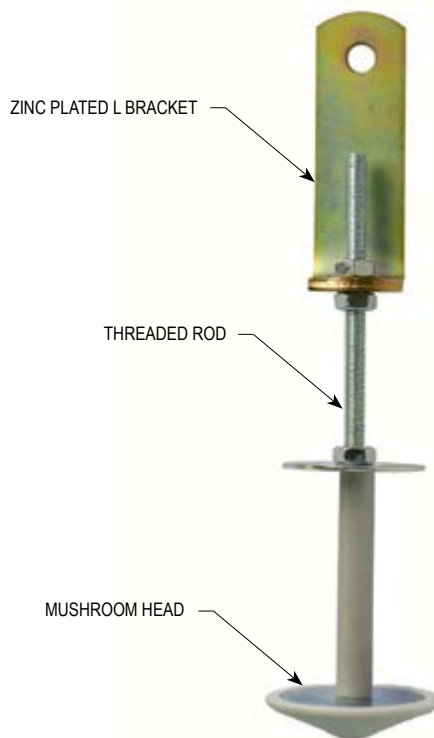

Delta Coldroom Insulated Mobile Growing Rooms



DELTA ARCHITECTURAL & HOUSING RANGE



DELTA ARCHITECTURAL & HOUSING RANGE

Architectural Panels

› DeltaCool-EPS-FR

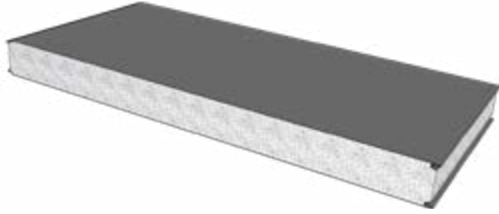

› DeltaSecretFix-EPS-FR

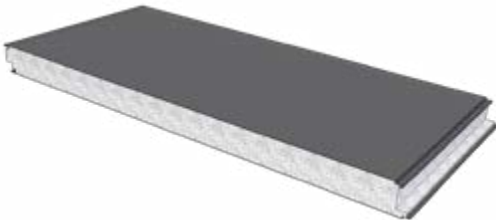

› DeltaCool-TPC

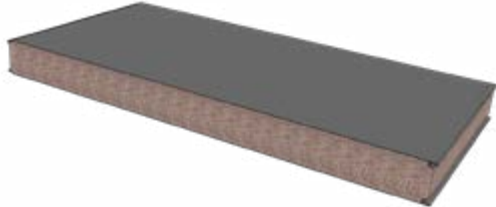

› DeltaSecretFix-TPC

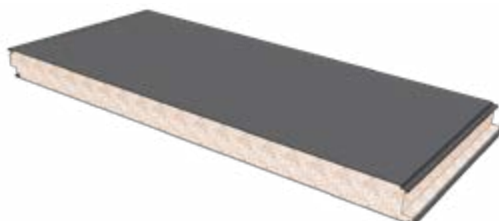

› DeltaCool-MW

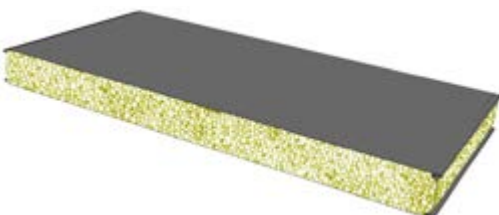

Facer Profiles

- Smooth
- Ribbed
- 5V
- Micro Ribbed
- SingleV

Fire Ratings

Fire Test Certificate - AS ISO 9705		
Group 1 Classification in accordance with NCC Volume One Specification BCA2022 C2D11 & Specification 7, Fire Hazard Properties, Clause S7C4 determined in accordance with AS 5637.1:2015 as per BRANZ test report 374 Issue 2 on 23rd February 2021		
Early Fire Hazard Properties AS 1530-1999 AWTA Test Report 18-006076 14-11-2018 - EPS-FR		
Index	Test Range	External Top Skin
Ignitability	0-20	0
Spread of Flame	0-10	0
Heat Evolved	0-10	0
Smoke Developed	0-10	2

Fire Test Certificate - AS ISO 9705		
Group 1 Classification in accordance with NCC Volume One Specification BCA2022 C2D11 & Specification 7, Fire Hazard Properties, Clause S7C4 determined in accordance with AS 5637.1:2015 as per BRANZ test report FI6323-01-2 issued 23rd February 2021		
Early Fire Hazard Properties AS 1530.3:1999 AWTA Test Report 23-000591 20-02-2023 - TPC		
Index	Test Range	External Top Skin
Ignitability	0-20	0
Spread of Flame	0-10	0
Heat Evolved	0-10	0
Smoke Developed	0-10	1

Combustibility Test AS 1530.1-1994		
CSIRO Report no. FNC12604 dated 8/7/2020 tested five (5) samples of the Delta Panels supplied mineral wool sample and certified that the material is NOT deemed combustible according to the criteria specified in clause 3.4 of AS 1530.1-1994.		
Non-Combustibility Building Material - NCC Section C1.9		
The Delta Panels laminated mineral wool products are certified, by Milanovic Neale Consulting Engineers 28/8/2020, to meet the three performance criteria in the NCC (2019) Section C1.9 (non-combustible building elements).		
Early Fire Hazard Properties AS 1530.3:1999 AWTA Test Report 18-006075 14-11-2018-1989 - MW		
Index	Test Range	External Top Skin
Ignitability	0-20	0
Spread of Flame	0-10	0
Heat Evolved	0-10	0
Smoke Developed	0-10	2

DELTA ARCHITECTURAL & HOUSING RANGE



DELTA ARCHITECTURAL & HOUSING RANGE





Insulated Core Options

Delta Panels™ range of insulated panels utilises four (4) different core materials. Each of the core options offer different physical properties and are suitable for a range of applications.

Product Details

Expanded Polystyrene-FR (EPS-FR)

EPS-FR has an added fire retardant additive that allows the core to shrink away from any flame source. EPS-FR core allows for strong, light weight panels that are very cost effective in a variety of commercial and residential building applications.



Thermosetting Phenolic Composite (TPC)



The range of Delta Panels TPC core panels has been extensively independently tested. The panels have been certified as meeting the requirements of Group 1 classification in accordance with AS 5367.1.2015. Furthermore they have undergone AS 1530-1999 Early Fire Hazard Properties. The TPC core panels combine long spanning with excellent thermal performance. Patent Application 2022903579



DeltaDualCore (DC)

DeltaDual™ Core panels are specifically designed to allow the use of insulated panels where the National Construction Code requires a noncombustible building product within 900mm of a boundary. This is achieved through having a mineral wool core in the 1000mm end of a panel used near the boundary line. The balance of the core material can consist of either Expanded Polystyrene with fire retardant (EPS-FR) or Thermosetting Phenolic Composite (TPC). DeltaDual Core panels are covering by the Innovation Patent No. 2011104435



Mineral Wool (MW)

The Delta Panels range of laminated Mineral Wool panels are certified by Milanovic Neale Consulting Engineers to meet the three (3) performance criteria in the NCC (2019) Section 1.9 (non-combustible building elements). The CSIRO report no. FNC 12604, certified that the five (5) mineral wool samples were NOT deemed combustible according to the criteria in clause 3.4 of AS 1530.1:1994. As there are no thermal bridges, Mineral Wool possesses good thermal insulation properties.

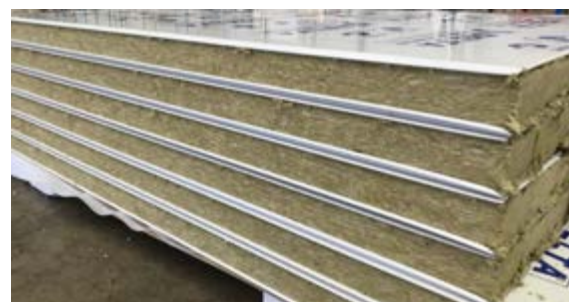



Core Material Comparisons

CORE MATERIAL	Expanded Polystyrene with Fire Retardant	Thermosetting Phenolic Composite	Mineral Wool			
	EPS-FR	TPC	MW			
ACOUSTIC CHARACTERISTICS						
Frequency: 50mm - 150mm Panel -STC	25dB	25dB	25dB			
CORE CHARACTERISTICS						
Core Density	13.5kg/m ³	36kg/m ³	100kg/m ³			
THERMAL CONDUCTIVITY						
W/mK @ 23C	0.042	0.039	0.0365			
ENERGY PERFORMANCE						
	External Roof		External Roof		External Wall	
	Winter (15°C)	Summer (23°C)	Winter (15°C)	Summer (23°C)	Winter (15°C)	Summer (23°C)
R Value: 50mm Panel	1.38	1.36	1.45	1.45	-	-
R Value: 75mm Panel	1.90	1.85	2.10	2.05	2.25	2.15
R Value: 100mm Panel	2.52	2.43	2.75	2.65	2.95	2.85
R Value: 150mm Panel	3.69	3.56	4.05	3.90	4.40	4.20
R Value: 200mm Panel	4.88	4.68	5.40	5.20	-	-
FIRE PERFORMANCE INFORMATION						
C1.1 Non Combustible C1.9e	Combustible	Combustible	Non-Combustible			
Early fire hazard properties (A.S. 1530.3 1999)	Ignitability - 0	Ignitability - 0	Ignitability - 0			
	Spread of Flame - 0	Spread of Flame - 0	Spread of Flame - 0			
	Heat Evolved - 0	Heat Evolved - 0	Heat Evolved - 0			
	Smoke Developed - 2	Smoke Developed - 1	Smoke Developed - 2			
AS/ISO 9705 classification	Group 1	Group 1	Group 1			
Factory Mutual (FM Approved)	-	FM 4880, 4881, 4882, 4471	-			
SMORGA (m2/S2 x 1000)	3.8	2.2	N/A			
Non Load Bearing Wall (AS 1530.4:2014)	N/A	N/A	-/60/120			
Bushfire Attack Level (BAL)	-	BAL-29	-			
PHYSICAL INFORMATION						
Panel Weights: 0.6mm skins at 100mm core	11.30kgs/m ²	14.2kgs/m ²	20.25kgs/m ²			
Recyclability	Yes	Yes	Limited			
Safety handling requirements	Safety Data Sheet	Safety Data Sheet	Safety Data Sheet			

DELTA PANELS - PHYSICAL PROPERTIES

Joiner Options

Tongue & Groove Joiner

The edges of the steel facer are roll formed to form a tongue and groove interlocking joining system. This joined seam can be sealed with a sealant to form a waterproof barrier.

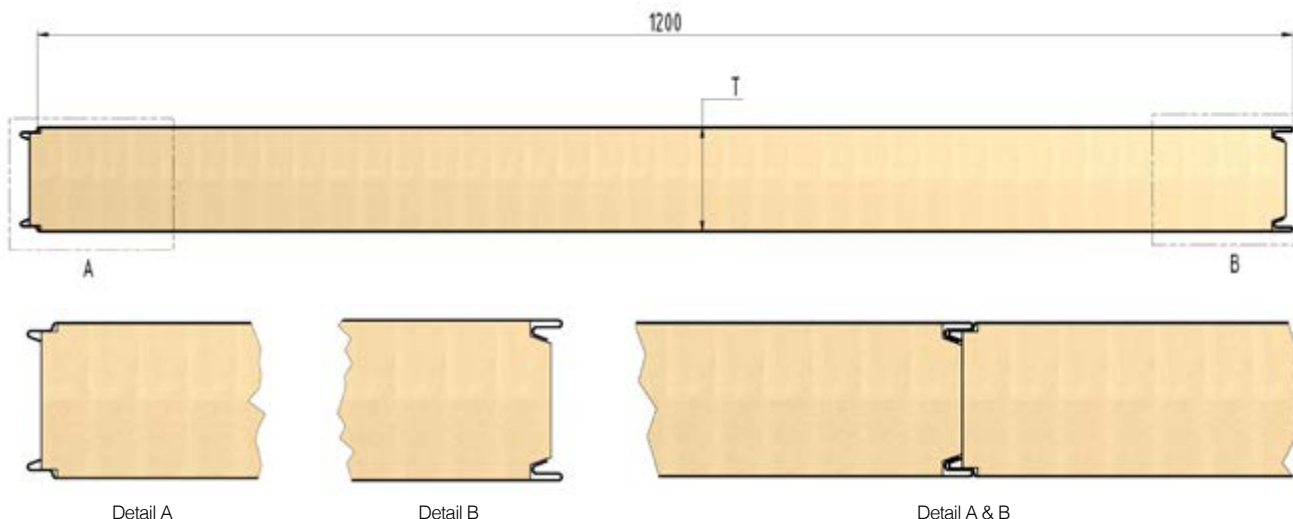

SecretFix Joiner

The SecretFix Joiner edges of the steel facer are offset to form a tongue and groove interlocking joining system that can accommodate a fixing plate. This joined seam can be installed without any visible fixings, making it ideal for Architectural applications.

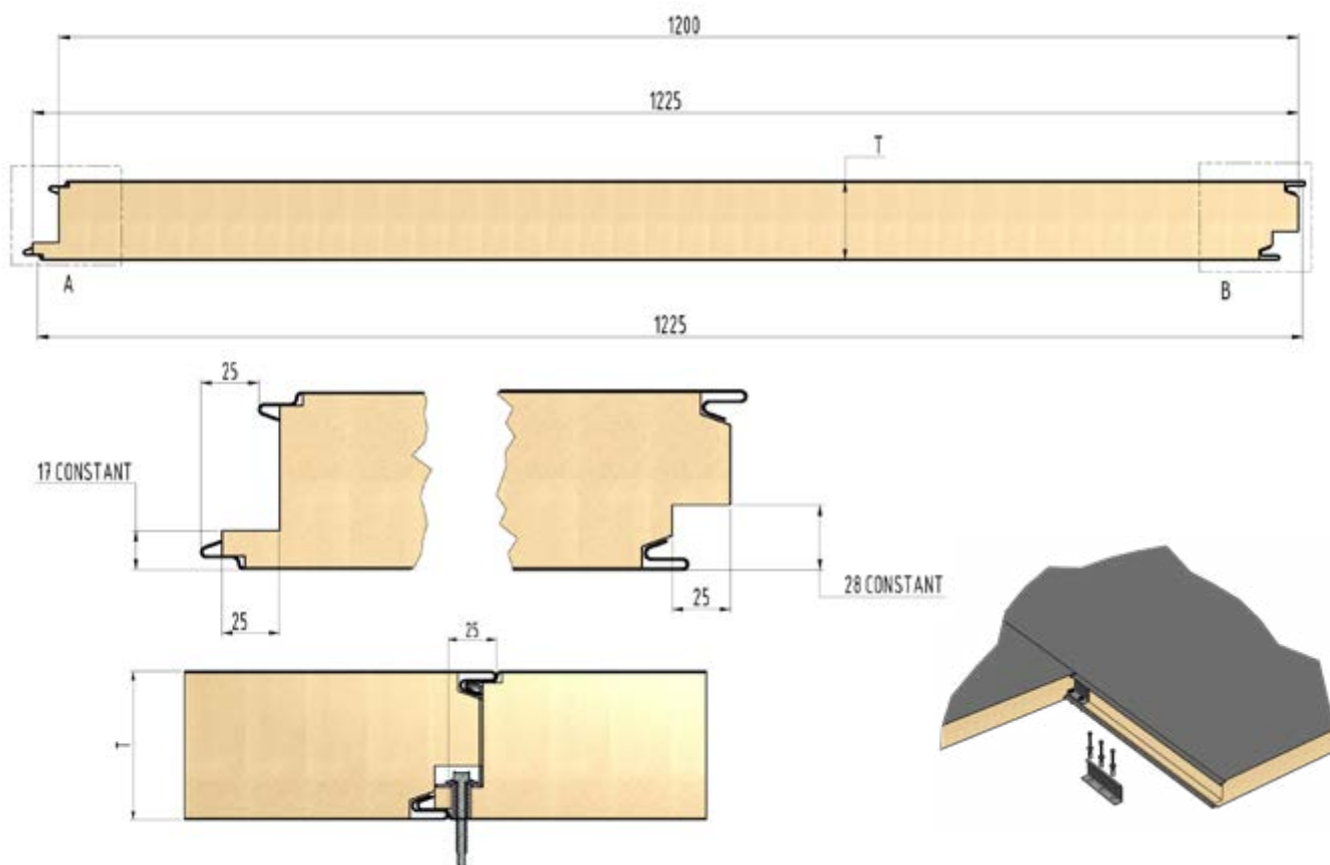

DELTA PANELS - PHYSICAL PROPERTIES

Facer Options

All the Delta Panels™ Architectural Range of Panels are available not only in an extensive range of contemporary colours but also with a variety of facer profiles. These facer profiles allow the panels to be utilised in a wide array of applications.

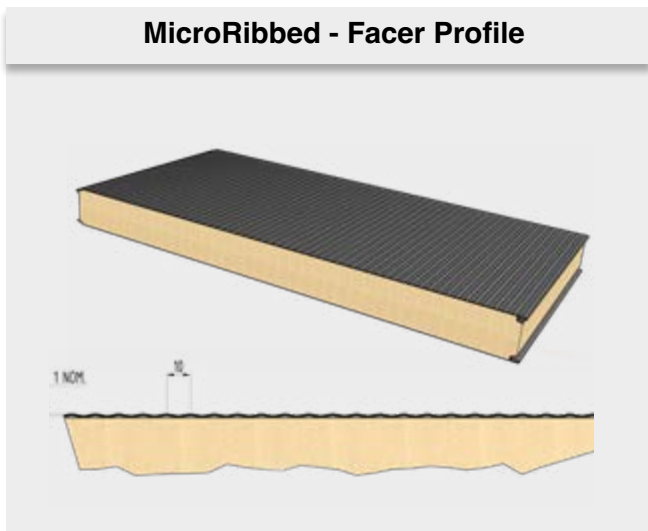
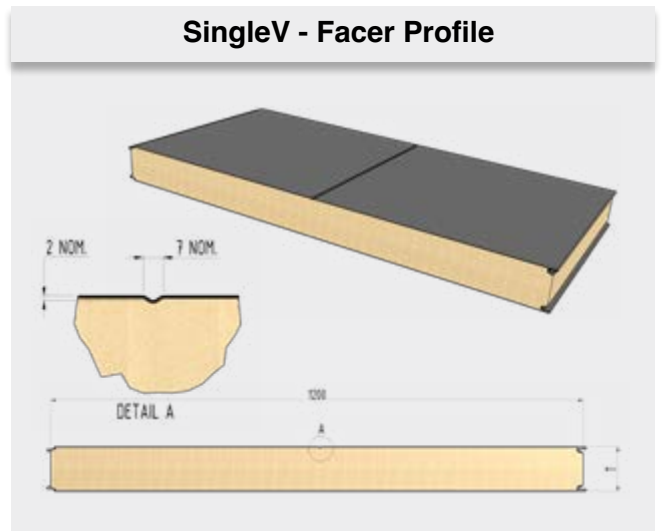
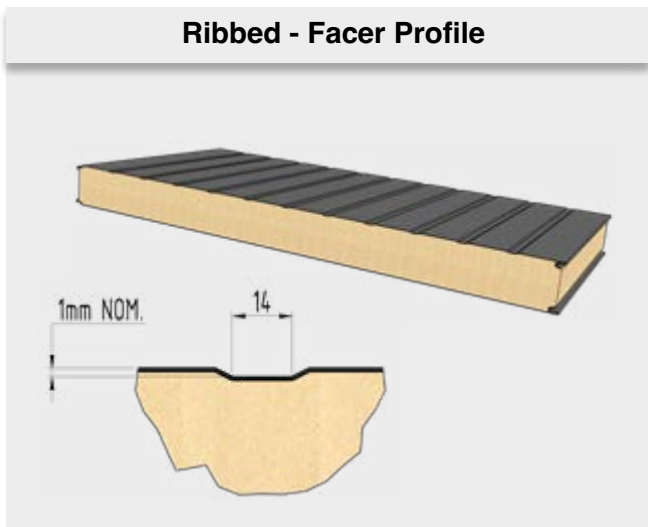
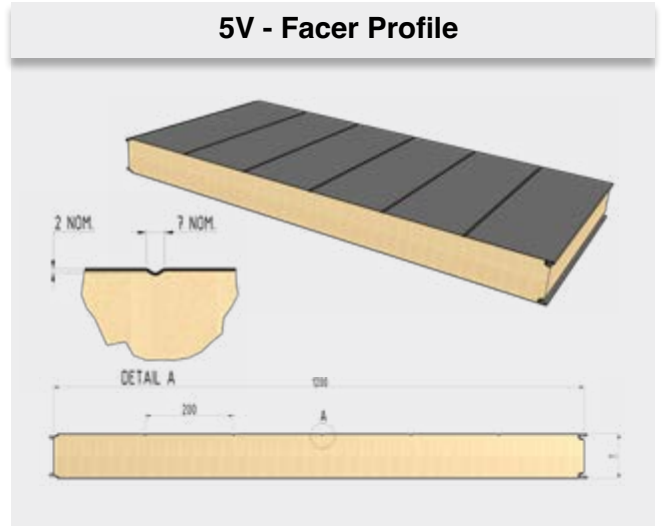
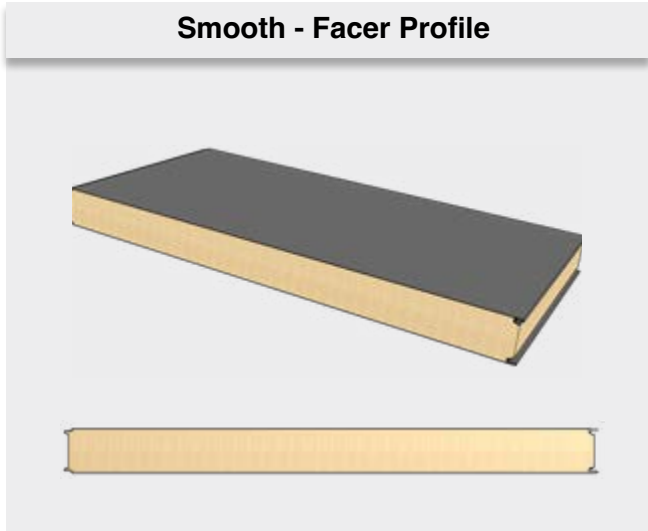

DELTA PANELS - PHYSICAL PROPERTIES

Testing

Delta Panels™ are engaged with a range of international testing authorities to ensure that their products meet all statutory and building codes. Our testing regime is ongoing and all updated and additional test reports are available on our web page.

Testing Authorities

- Factory Mutual - USA**
 DeltaCool-TPC™, DeltaTrim-TPC™, DeltaOrb-TPC™ & DeltaCorroCorro-TPC™
 - **FM4880, FM4881, FM4882 & FM4471 Certification**
- BRANZ - New Zealand**
 DeltaCool-TPC™
 - **AS ISO 9705:2003- Room Test**
 DeltaCool-MW™
 - **AS 1530.4:2014 - Fire Resistance of a Non-Load Bearing Wall**
 DeltaCool-EPS-FR™
 - **AS 3959:2018 - Bal29**
 DeltaCool-TPC™
 - **AS ISO 9705:2003- Room Test**
 DeltaTrim-EPS-FR™ & DeltaOrb-EPS-FR™
 - **AS 3959:2018 - Bal40**
 EPS-FR, TPC & MW Core material
 - **ASTM C518 - Thermal Resistance**
- CSIRO**
 Mineral Wool
 - **AS 1530.1:1994 - Non-Combustibility**
 EPS-FM & TPC
 - **ASTM C518 - Thermal Resistance**
 DeltaCool-TPC™, DeltaTrim-TPC™ & DeltaOrb-TPC™
 - **AS 3959:2018 - Bal29**
- AWTA - Australia**
 DeltaCool-EPS-FR™
 - **AS/NZ 1530.3:1999 Methods of Fire Tests on Building Materials**
 DeltaCool-TPC™
 - **AS/NZ 1530.3:1999 Methods of Fire Tests on Building Materials**
 DeltaCool-MW™
 - **AS/NZ 1530.3:1999 Methods of Fire Tests on Building Materials**
- AHSCA**
 DeltaTrim™ & DeltaOrb™
 - **AS 1562.1:2018 - Drainage Capacity**
- VIPAC**
 - **AS/NZS 4284:2008 - Weatherproof**
- Certified Engineers**
 Delta Panels™ utilises the services of the following certified Engineers to compile all of our published engineering data
- Acronem Consulting Australia Pty Ltd**
 - **Thermal Performance Reporting**
- S J George Meija**
 Registered Professional Engineer QLD 742.
- Ron Bell - Summermore Pty Ltd**
 Registered Engineer Structural.
- Milanovic Neale**
 Consulting Engineers









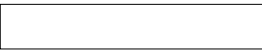

DELTA PANELS - PHYSICAL PROPERTIES

Testing

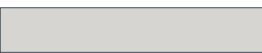

COLOUR CHART

BLUESCOPE®™ / Colorbond

COLOUR		PRODUCT						
		DeltaTrim™ Top	DeltaTrim™ Bottom	DeltaOrb™ Top	DeltaOrb™ Bottom	DeltaCorroCorro™ Top/Bottom	DeltaCool™ 0.40mm	DeltaCool™ 0.60mm
	Thredbo White ®							●√
	Surfmist ®	●+√	●√	●+√	●√	●+√	●√	●√
	Classic Cream™	●+√		●+√		●+√		●√
	Shale Grey™							●√
	Paperbark ®	●+√		●+√		●+√		●√
	Basalt ®	●√		●√		●√		●√
	Pale Eucalypt ®							●√
	Woodland Grey ®	●√		●√		●√		●√
	Monument ®	●√		●√		●√		●√
	Night Sky ®							●√

® Colour names are registered trademarks of Bluescope Steel Limited.



™ Colour names are trademarks of Bluescope Steel Limited.

+ Roof Colours fully covered by our Warranty. For full details refer to the Terms & Conditions as outlined in the Warranty - Roof Products document.

√ Range of COLORBOND® steel colours held in stock.

UNICOTE® / LUX

Delta Panels™ offers a selection of modern patterned and textured steel finishes in our DeltaLux™ range of Wall and Roof panels.

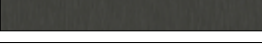
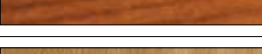
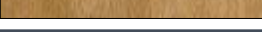
COLOUR		DeltaTrim™ Bottom	DeltaOrb™ Bottom	DeltaCool™ 0.60mm
	Metal Stone / LUX			●
	Spectrum / LUX			●
	Weathered Iron / LUX			●
	Zinc Graphite / LUX			●
	Ash Wood / LUX	●	●	
	Maple / LUX	●	●	

COLOUR CHART

UNICOTE®

COLOUR		PRODUCT										
		DeltaTrim™ Top	DeltaTrim™ Bottom	DeltaOrb™ Top	DeltaOrb™ Bottom	DeltaCorroCorro™ Top/Bottom	DeltaMax™ Top	DeltaMax™ Bottom	DeltaCool™ 0.40mm	DeltaCool™ 0.60mm	DeltaSingle™	DeltaBeam™
	Hamptons White	●+	●	●+	●	●+						
	Off White	●+	●	●+	●	●+	●+	●	●	●	●*	●
	Smooth Cream	●+	●	●+	●	●+					●*	
	Gull Grey	●+		●+		●+						
	Merino	●+		●+		●+						
	Basal	●		●		●						
	Birch	●+		●+		●+	●+					
	Mist Green	●+		●+		●+						
	Armour Grey	●+		●+		●+						
	Jasmin Brown	●		●		●						
	Slate Grey	●		●		●						
	Iron Grey	●		●		●						
	Heritage Red	●		●		●						
	Caufield Green	●		●		●						
	Monolith	●		●		●					●**	
	Mountain Blue	●		●		●						
	Zinc	●+		●+		●+						
	Wallaroo	●		●		●						
	Ebony											●
	Other	●		●		●	●	●		●		●
		Project Volume Only		Project Volume Only		Project Volume Only	Project Volume Only	Project Volume Only		Project Volume Only		Powder-Coat to Order

* DeltaSingle™ colours are 80% gloss level on the ceiling, standard gloss level on the roof.

** Underneath colour is Off White at 80% gloss level.

+ Roof Colours fully covered by our Warranty. For full details refer to the Terms & Conditions as outlined in the Warranty - Roof Products document.

Reference Library

Delta Panels™ Pty Ltd is committed to an ongoing programme of product research and development and reserves the right to update and amend information without prior notice. Reasonable care has been taken to ensure that all published information is correct and accurately reflects the properties of our products and their design applications at the time of publication. However these are a general guide only, it is the customers responsibility to ensure that all products and their stated applications are fit for purpose and complies with all relevant statutory requirements.

To ensure that you keep abreast of all updates in our product range, all current reference material are available on our web page for downloading.

- Acoustic Measurement Reports - CSIRO
- Thermal Performance Tests - CSIRO
- CodeMark Australia Certificate – CM40309, CM40330, CM40345, CM40346 & CM40365
- Colour Range
- Core Material Comparisons
- Drainage Capacity Test – AS1562.1:2018
- Engineering Module A – Awnings, Patios & Carports Engineering & Construction Manual
- Engineering Module B – Awnings, Patios & Carports Pre-Engineered Kits
- Engineering Module C – Gable Roofing Engineering & Construction Manual
- Engineering Module D – Brackets, Fixings, Flashings & Accessories Manual
- Engineering Module E – Residential Engineering Manual
- Engineering – Non-Combustible Certification – Mineral Wool Panels
- Factory Mutual Certifications – FM4880, FM4881, FM4882 & FM4471
- Fire Engineering Report - DeltaDualCore, DeltaFireX & DeltaMW & EPS-FR
- Fire Test -
 - Expanded Polystyrene
 - Fire Retardant (EPS-FR) BAL 29/40 – Branz
 - Fire Retardant (EPS-FR) -AS 1530.3-1999 - AWTA
 - Thermosetting Phenolic Composite (TPC)
 - Group 1 – ISO 9705 - Branz
 - AS 1530.3-1999 - AWTA
 - AS 3959:2018 - BAL29
 - Mineral Wool (MW)
 - AS 1530.3-1999 - AWTA
 - FRL – Branz
 - AS 1530.1-1994 - CSIRO
- Flashings – Recommended installation
- Handling & Installation Manual – Roofing Systems
- Handling & Installation Manual – Wall Systems
- Lighting – DeltaLowProfile™ – Installation Guideline
- Lighting – DeltaLum™ – Installation Guideline
- Product Catalogue – Delta Panels™ Product Range
- Product Catalogue – DeltaDualCore™
- Product Catalogue – DeltaFireX™
- Product Catalogue – DeltaMax™
- Product Catalogue – DeltaCool™ - Coldroom Range
- Product Catalogue – Insulated Roofing
- Product Catalogue – DeltaLowProfile™
- Product Catalogue – DeltaLum™
- Product Catalogue – DeltaSingle™
- Product Catalogue – DeltaSkylights™
- Product Catalogue – DeltaBeam™
- Product Catalogue – Post Kits & Extender Posts
- Product Data Sheets – Expanded Polystyrene – Fire Retardant (EPS-FR) Roof & Wall Panels
- Product Data Sheets – Thermosetting Phenolic Composite (TPC) Roof & Wall Panels
- Product Data Sheets – Mineral Wool (MW) Roof & Wall Panels
- Product Data Sheets – DualCore (DC) Roof Panels
- Safety Data Sheets – EPS-FR, TPC & MW
- Thermal Performance Reports - Acronem Consulting
- Warranty – Walls, Roof, Beams & Lighting Systems
- Weatherproof Report
- Wind Speed Calculation Guide

DeltaMax™, DeltaTrim™, DeltaOrb™, DeltaCorroCorro™, DeltaTrimTrim™, DeltaTrimCorro™, DeltaDualCore™, DeltaSingle™, DeltaBeam™, DeltaXtremeBeam™, DeltaLowProfile™ & DeltaCleanSpec™ are all trademarks of Delta Panels™ Pty Ltd





Delta Panels™ Pty Ltd is committed to an ongoing programme of product research and development and reserves the right to update and amend information without prior notice. Reasonable care has been taken to ensure that all published information is correct and accurately reflects the properties of our products and their design applications at the time of publication. However these are a general guide only, it is the customers responsibility to ensure that all products and their stated applications are fit for purpose and complies with all relevant statutory requirements. To ensure that you keep abreast of all updates in our product range, all current reference material are available on our web page for downloading.

All information contained within this document is subject to Copyright and may not be copied without the express permission of Delta Panels™ Pty Ltd.

DeltaMax™, DeltaTrim™, DeltaOrb™, DeltaCorroCorro™, DeltaTrimTrim™, DeltaTrimCorro™, DeltaDualCore™, DeltaSingle™, DeltaBeam™, DeltaXtremeBeam™ & DeltaLowProfile™ are all trademarks of Delta Panels™ Pty Ltd